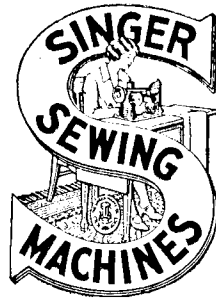


# **SINGER**

**148-6**

# LIST OF PARTS



## MACHINE No. 148-6

THE SINGER MANUFACTURING COMPANY

## INDEX

	PAGE
ACCESSORIES.....	19
BELT GUARD.....	20
FOOT LIFTER PARTS.....	20
IRON BASE.....	19
MACHINE No. 148-5.....	7
NUMERICAL LIST OF PARTS.....	23
TAPE HOLDERS.....	21
THREAD UNWINDER.....	21

From the library of: Diamond Needle Corp



NO.	PLATE	NAME
128002	9119	Arm Rock Shaft.....
128003	9101	“ “ “ Bushing (back).....
437c	9118	“ “ “ “ “ S e t Screw.....
128004	9101	Arm Rock Shaft Bushing (front).....
888c	9118	“ “ “ “ “ S e t Screw.....
54919	9101	Arm Rock Shaft Bushing (intermediate)
50224c	9118	“ “ “ “ “ Set Screw.....
54921	9101	Arm Rock Shaft Collar with two 456c..
456c	9101	“ “ “ “ Set Screw.....
128262	9122	“ “ “ Crank (back) with two 50083c, for 128261.....
128006	9122	Arm Rock Shaft Crank (back) with two 50083c, for 128021.....
50083c	9701	Arm Rock Shaft Crank (back) Set Screw
128007	9109	“ “ “ “ (front) with two 50135c.....
50135c	9701	Arm Rock Shaft Crank (front) Set Screw
56016	9150	“ Side Cover.....
286d	9118	“ “ “ Thumb Screw.....
128264	9150	Crank Connecting Rod complete, Nos. 217b, 1722e, 1723e, 51616, 51925, 55034 and 128267.....
*54925	—	Crank Connecting Rod (rod only).....
51043c	9122	“ “ “ Ball Screw Stud
1597e	9118	“ “ “ “ “ “ Nut.....
67425	9122	Crank Connecting Rod Ball Screw Stud Nut Lock Washer.....
*54612	—	Crank Connecting Rod Cap (lower)
896e	9117	“ “ “ “ “ Screw.....
*128265	—	Crank Connecting Rod Cap (upper)
171e	9117	“ “ “ “ “ Screw.....
*54614	—	Crank Connecting Rod End Bearing (lower).....
*128266	—	Crank Connecting Rod End Bearing (upper).....
*54616	—	Crank Connecting Rod Head (lower), Nos. 54612, 54614 and two 896e.....
*128267	—	Crank Connecting Rod Head (upper) Nos. 51043c, 128265, 128266 and two 171e.....

NO.	PLATE	NAME
1722e	9122	Crank Connecting Rod Nut (lower)....
1723e	9122	“ “ “ “ (upper)....
55034	9101	“ “ “ Position Plate
217d	9117	“ “ “ “ “ Screw.....
*128309	—	Cylinder with 452c, 460c, 50150c, 51661, 128032, 128033 and two 391b.....
54620	9101	Cylinder Dowel Pin.....
128310	9150	“ End Cover.....
128311	—	Cylinder End Cover complete, Nos. 128128, 128310, 128312, two 233b, 1477b, 128013, 128313, three 1231a and four 405b.....
128312	9701	Cylinder End Cover Cap.....
1477b	9701	“ “ “ “ Screw.....
128013	9101	“ “ “ Lock Spring.....
405b	9118	“ “ “ “ Screw.....
*54625	—	“ “ “ Slide (back).....
128128	9102	“ “ “ “ “ 54625 with 54627 and 55165.....
50999e	9117	Cylinder End Cover Slide (back) Stop Screw.....
*55165	—	Cylinder End Cover Slide (front).....
54627	9102	“ “ “ “ “ Hinge Pin.....
1231a	9118	Cylinder End Cover Slide (front) Screw.
128313	9700	“ “ “ Tape Guide.....
233b	9117	“ “ “ “ “ Screw
128014	9150	“ Rock Shaft.....
128015	9102	“ “ “ Bushing (back)....
1125c	9118	“ “ “ “ “ Set Screw.....
128016	9102	Cylinder Rock Shaft Bushing (front)....
220b	9117	“ “ “ “ “ Set Screw.....
128017	9102	Cylinder Rock Shaft Crank with two 1253c.....
1253c	9102	Cylinder Rock Shaft Crank Set Screw..
128018	9102	“ “ “ Connection with 128019, 128020 and two each 152e and 175e.....
128121	—	Cylinder Rock Shaft 128018 with 128014, 128038 and 128041.....
*128019	—	Cylinder Rock Shaft Connection Cap (large).....
152e	9102	Cylinder Rock Shaft Connection Cap (large) Screw.....

NO.	PLATE	NAME
*128020	—	Cylinder Rock Shaft Connection Cap (small).....
175E	9102	Cylinder Rock Shaft Connection Cap (small) Screw.....
128021	9150	Cylinder Rock Shaft Connecting Rod complete, Nos. 1722E, 1723E, 128022, 128025 and 128026.....
128022	—	Cylinder Rock Shaft Connecting Rod (rod only).....
50730c	9102	Cylinder Rock Shaft Connecting Rod Ball Screw Stud (lower).....
1664E	9118	Cylinder Rock Shaft Connecting Rod Ball Screw Stud (lower) Nut.....
50731c	9102	Cylinder Rock Shaft Connecting Rod Ball Screw Stud (upper).....
1597E	9118	Cylinder Rock Shaft Connecting Rod Ball Screw Stud (upper) Nut.....
*128023	—	Cylinder Rock Shaft Connecting Rod Cap (lower).....
174E	9117	Cylinder Rock Shaft Connecting Rod Cap (lower) Screw.....
*54613	—	Cylinder Rock Shaft Connecting Rod Cap (upper).....
171E	9117	Cylinder Rock Shaft Connecting Rod Cap (upper) Screw.....
*128024	—	Cylinder Rock Shaft Connecting Rod End Bearing (lower).....
*55032	—	Cylinder Rock Shaft Connecting Rod End Bearing (upper).....
125601	—	Cylinder Rock Shaft Connecting Rod End Bearing (upper) 55032 with 54613 and two 171E.....
128025	—	Cylinder Rock Shaft Connecting Rod Head (lower), Nos. 50730c, 128023, 128024 and two 171E.....
128026	—	Cylinder Rock Shaft Connecting Rod Head (upper), Nos. 217D, 50731c, 55034 and 125601.....
1722E	9122	Cylinder Rock Shaft Connecting Rod Nut (lower).....
1723E	9122	Cylinder Rock Shaft Connecting Rod Nut (upper).....
55034	9101	Cylinder Rock Shaft Connecting Rod Position Plate.....
217D	9117	Cylinder Rock Shaft Connecting Rod Position Plate Screw.....

NO.	PLATE	NAME
128027	—	Cylinder Rock Shaft Eccentric.....
50589c	9109	“ “ “ “ Regulating Screw.....
198D	9109	Cylinder Rock Shaft Eccentric Set Screw
134D	9117	“ Screw.....
128314	9700	“ Tape Guide (back) with 811E and 128315.....
128315	9700	Cylinder Tape Guide (back) Roller.....
811E	9700	“ “ “ “ “ Screw.....
224	9700	“ “ “ “ “ Screw.....
128316	9700	“ “ “ “ (front).....
337J	9131	“ “ “ “ “ Screw.....
128028	9102	“ Thread Eyelet.....
128139	—	“ “ “ “ 128028 with 128166.....
1402D	9117	Cylinder Thread Eyelet Screw.....
128030	9102	“ “ “ Guard.....
1302D	9118	“ “ “ “ “ Screw.....
128031	9103	“ “ “ Tube.....
128032	9103	“ “ “ Top Cover (back).....
54664	9109	“ “ “ “ “ Hinge Pin
460c	9118	“ “ “ “ “ “ “ “ Set Screw.....
128033	9103	Cylinder Top Cover (front) with 233D and 128034.....
391D	9118	Cylinder Top Cover (front) Screw.....
128034	9109	“ “ “ “ “ Spring.....
233D	9117	“ “ “ “ “ “ “ Screw
128317	9150	Face Plate.....
128318	—	Face Plate complete, Nos. 621D, 55184 and 128317.....
46111	9102	Face Plate Pin.....
55184	9101	“ “ “ “ “ Thread Guide.....
621D	9118	“ “ “ “ “ “ “ Screw.....
286D	9118	“ “ “ “ “ Thumb Screw.....
50732c	9117	Feed Adjusting Screw (eccentric).....
4735J	9118	“ “ “ “ “ Nut.....
128319	9700	“ Dog, 16 teeth (18 teeth to the inch)
50128c	9117	“ “ “ “ “ Screw.....
128038	9112	“ Connecting Rod with 128039 and two 896E.....
*128039	—	Feed Connecting Rod Cap.....
896E	9117	“ “ “ “ “ “ “ Screw.....
*128040	—	“ Eccentric.....
128041	9109	Feed Eccentric (adjustable) complete, Nos. 198D, 50589c, 128027, 128040 and 128174.....

NO.	PLATE	NAME
*128174	—	Feed Eccentric Body with two 1143c...
1143c	9109	“ “ “ Set Screw.....
128042	9109	“ Lifting Eccentric with two 462c...
128122	—	“ “ “ 128042 with 54953
462c	9118	“ “ “ Set Screw.....
128043	9112	“ “ Lever.....
54953	9109	“ “ “ Connecting Rod with 54940 and two 896e.....
*54940	—	Feed Lifting Lever Connecting Rod Cap
896e	9117	“ “ “ “ “ “ Screw.....
50997c	9117	Feed Lifting Lever Connecting Rod Hinge Screw (eccentric).....
1722e	9122	Feed Lifting Lever Connecting Rod Hinge Screw Nut.....
128044	9102	Feed Lifting Lever Hinge Pin.....
452c	9122	“ “ “ “ “ Set Screw
128045	9109	“ Regulator.....
54958	9102	“ “ Friction Spring.....
128046	9109	“ “ Pawl with two 453c....
128047	9150	“ “ “ Lever with 448c....
448c	9701	“ “ “ “ Set Screw..
128048	9102	“ “ “ “ Stud.....
42833	9102	“ “ “ “ “ Spring
453c	9701	“ “ “ “ Set Screw.....
128049	9102	“ “ “ “ Shaft.....
128050	9112	“ Rod.....
128051	9102	“ “ Connecting Link (left).....
128052	9102	“ “ “ “ (right).....
50733c	9117	“ “ “ “ “ Hinge Screw
1735j	9118	“ “ “ “ “ “ Nut.....
128053	9111	Feed Rod Hinge Bracket with 50150c
128054	9111	“ “ “ “ “ Hinge Pin....
50150c	9701	“ “ “ “ “ “ Set Screw.....
128055	9102	Feed Rod Hinge Pin.....
50150c	9701	“ “ “ “ “ Set Screw.....
*128334	—	Hand Wheel.....
128335	9137	Hand Wheel and Pulley complete, Nos. 128334, 128337 and two 50084c.....
50084c	9122	Hand Wheel and Pulley Set Screw.....
128336	9143	“ “ “ “ “ Shaft.....
128340	—	“ “ “ “ “ 128336 with 54616.....
128125	—	Hand Wheel and Pulley Shaft 128340 with 128045, 128122 and 128124.....

NO.	PLATE	NAME
54968	9112	Hand Wheel and Pulley Shaft Bushing (right).....
41128	9111	Hand Wheel and Pulley Shaft Bushing (right) Oil Pad (braided cotton).....
888c	9118	Hand Wheel and Pulley Shaft Bushing (right) Set Screw.....
128388	9701	Hand Wheel and Pulley Shaft Flanged Bushings (left).....
42365	9111	Hand Wheel and Pulley Shaft Flanged Bushings (left) Oil Pad (braided cotton)
445c	9122	Hand Wheel and Pulley Shaft Flanged Bushings (left) Set Screw.....
150d	9701	Hand Wheel and Pulley Shaft Screw...
54970	9101	“ “ “ “ “ Washer..
128058	9110	Looper (back).....
128059	9110	“ “ “ Carrier with 1451c....
1451c	9110	“ “ “ “ Clamping Screw.
128060	9110	“ (front).....
128061	9110	“ “ “ Carrier with 1454c....
1451c	9110	“ “ “ “ Clamping Screw.
399d	9118	“ “ “ “ “ Screw.....
54708	9112	Needle Bar (hollow).....
54846	—	Needle Bar complete, Nos. 54708 and 54847.....
54710	9111	Needle Bar Bushing (lower).....
563c	9118	“ “ “ “ “ Set Screw..
54710	9111	“ “ “ “ (upper).....
563c	9118	“ “ “ “ “ Set Screw..
*54711	9111	“ “ “ “ “ Connecting Link.....
128126	—	“ “ “ “ “ 54711 with 54712 and 128118.....
54712	9110	Needle Bar Connecting Link Hinge Stud
1520j	9118	“ “ “ “ “ “ Nut.....
128117	9111	Needle Bar Connecting Stud with 207e.
207e	9111	“ “ “ “ “ Clamping Screw.....
128118	—	Needle Bar Connecting Stud complete, Nos. 220d, 1332d, 54716, 128117, 128119 and 128120.....
128119	9111	Needle Bar Thread Retainer.....
128120	9701	“ “ “ “ “ Bracket
220d	9117	“ “ “ “ “ “ Screw.....
54716	9111	Needle Bar Thread Retainer Spring
1332d	9117	“ “ “ “ “ “ Screw.....

From the Library of Diamond Needle Corp.

NO.	PLATE	NAME
54847	9111	Needle Clamp with 46478 and two 1498F
46478	9111	" " Thread Guide.....
128062	9111	" Guard (back) for $\frac{1}{4}$ in. gauge and below.....
128256	9701	Needle Guard (back) for $\frac{3}{8}$ in. and $\frac{5}{16}$ in. gauges.....
233D	9117	Needle Guard (back) Screw.....
128063	9111	" " (front) for $\frac{1}{4}$ in. gauge and below.....
128257	9701	Needle Guard (front) for $\frac{3}{8}$ in. and $\frac{5}{16}$ in. gauges.....
233D	9117	Needle Guard (front) Screw.....
54977	9111	" " Holder.....
185H	9117	" " " " Screw.....
1498F	9111	" Set Screw.....
55084	9110	Presser Bar (lower).....
128064	9111	" " " " Bushing.....
563C	9118	" " " " Set Screw..
128065	9150	" " (upper).....
128066	9110	" " " " Guide Bracket with 440c.....
440C	9701	Presser Bar (upper) Guide Bracket Set Screw.....
128067	9701	Presser Bar Connecting Bracket with 448c and 453c.....
448C	9701	Presser Bar Connecting Bracket Set Screw (long).....
453C	9701	Presser Bar Connecting Bracket Set Screw (short).....
128068	9110	Presser Bar Lifter.....
128069	9110	" " " " Connecting Link.....
50116F	9117	" " " " " " Hinge Screw (long).....
108F	9117	Presser Bar Lifter Connecting Link Hinge Screw (short).....
50415C	9117	Presser Bar Lifter Hinge Screw.....
2269	9110	" " " " Stop Pin (lower)....
2049	9110	" " " " " (upper)....
128070	9103	" " Lifting Lever.....
128071	9112	" " " " Extension.....
161C	9117	" " " " " " Screw.....
866D	9117	Presser Bar Lifting Lever Hinge Screw..
184D	9110	" " " " Stop Screw...
128072	9103	" " Spring (flat).....
54722	9111	" " " Stud.....
26276	9121	" Foot Hinge Pin.....

NO.	PLATE	NAME
128320	---	Presser Foot Plate.....
54819	---	" " Shank.....
128321	9700	Presser Foot (hinged) complete, for $\frac{1}{4}$ in. to $\frac{5}{16}$ in. gauges, Nos. 26276, 54819, 128320 and two each 337J and 128322
128322	9700	Presser Foot Needle Guard.....
337J	9131	" " " " Screw.....
190D	9117	" " Screw.....
50132W	9118	Pressure Regulating Thumb Screw.....
1543W	9118	" " " " Lock Nut.....
*128337	- -	Pulley, 27 <sub>8</sub> in. diam.....
128075	9110	Tension (under thread) Bracket.....
176D	9117	" " " " Screw.....
2102	9131	" " " " Disc.....
51570C	9131	" " " " Regulating Thumb Nut.....
128076	9701	Tension (under thread) Releaser.....
233D	9117	" " " " Adjusting Screw.....
50076D	9117	Tension (under thread) Releaser Hinge Screw.....
32572	9131	Tension (under thread) Releasing Disc..
128077	9103	" " " " " Lever.....
63824	9131	" " " " " " Spring.....
1144D	9117	Tension (under thread) Releasing Lever Spring Screw.....
128078	9131	Tension (under thread) Releasing Pin...
50326C	9131	" " " " Screw Stud.....
59539	---	" " " " " " 50326c with 51570c.....
59534	9131	Tension (under thread) Spring.....
59537	9131	" " " " " Bushing (large).....
59538	9131	Tension (under thread) Spring Bushing (small).....
17547	9131	Tension (under thread) Thread Guide..
128079	9103	" (upper thread) Bracket with two 447c.....
376D	9118	Tension (upper thread) Bracket Screw..
128080	9701	" " " " " Thread Eyelet (double).....
330D	9118	Tension (upper thread) Bracket Thread Eyelet Screw.....
128081	9131	Tension (upper thread) Bracket Thread Eyelet Screw Washer.....

NO.	PLATE	NAME
2102	9131	Tension (upper thread) Disc.....
51570c	9131	“ “ “ Regulating Thumb Nut.....
32572	9131	Tension (upper thread) Releasing Disc..
128078	9131	“ “ “ “ Pin...
54989	9702	“ “ “ “ Shaft
128082	9702	“ “ “ “ “
		Crank with 452c.....
54873	9702	Tension (upper thread) Releasing Shaft Crank Link.....
110c	9117	Tension (upper thread) Releasing Shaft Crank Link Hinge Screw.....
452c	9122	Tension (upper thread) Releasing Shaft Crank Set Screw.....
128165	9702	Tension (upper thread) Releasing Shaft Spring.....
316c	9118	Tension (upper thread) Releasing Shaft Stop Screw.....
1547j	9118	Tension (upper thread) Releasing Shaft Stop Screw Nut.....
50326c	9131	Tension (upper thread) Screw Stud
59539	—	“ “ “ “ “
		50326c with 51570c.....
59536	9131	Tension (upper thread) Spring.....
59537	9131	“ “ “ “ Bushing (large).....
59538	9131	Tension (upper thread) Spring Bushing (small).....
17517	9131	Tension (upper thread) Thread Guide..
128083	9143	“ Releasing Arm with 51818.....
128084	9143	“ “ “ “ Connecting Rod
1521E	9118	“ “ “ “ “
		Nut.....
1131c	9117	Tension Releasing Arm Hinge Screw....
51818	9701	“ “ “ “ Roller and Screw Stud.....
128085	9110	Thread (under) Eyelet.....
620c	9118	“ “ “ “ Set Screw.....
128086	9702	“ “ “ “ Nipper Cam with 61121 and two 465c.....
128087	—	Thread (under) Nipper Cam Oil Pad (felt).....
128088	—	Thread (under) Nipper Cam Oil Pad Holder.....
128089	9110	Thread (under) Nipper Cam Oil Pad Holder 128088 with 128087.....

NO.	PLATE	NAME
465c	9702	Thread (under) Nipper Cam Set Screw..
128090	9110	“ “ “ “ Spring (lower)..
128091	9702	“ “ “ “ (upper)..
334b	9118	“ “ “ “ Screw...
128092	9115	“ “ “ “ Pull-off.....
229b	9117	“ “ “ “ Adjusting Screw
61121	9115	“ “ “ “ Position Pin...
128238	9702	“ “ “ “ Protector.....
228b	9702	“ “ “ “ Screw.....
128166	9102	“ “ “ “ Separator with 128094, 128095, 128167 and two 726b.....
128167	9102	Thread (under) Separator Thread Re- tainer (left).....
128094	9102	Thread (under) Separator Thread Re- tainer (right).....
726b	9102	Thread (under) Separator Thread Re- tainer Screw.....
128095	9102	Thread (under) Separator Thread Guide
128096	9115	“ “ “ “ Take-up with two 465c.
*128243	9143	“ “ “ “ Frame.....
128298	—	Thread (under) Take-up Frame complete, Nos. 128105, 128243 and 128299.....
*128299	9143	Thread (under) Take-up Frame Cover with 50150c.....
128105	9115	Thread (under) Take-up Frame Cover Hinge Pin.....
50150c	9701	Thread (under) Take-up Frame Cover Hinge Pin Set Screw.....
1149b	9702	Thread (under) Take-up Frame Screw..
128246	9702	“ “ “ “ Knife.....
128247	9702	“ “ “ “ “ Holder with 465c.....
185b	9117	Thread (under) Take-up Knife Holder Screw.....
465c	9702	Thread (under) Take-up Knife Set Screw
465c	9702	“ “ “ “ Set Screw.....
128097	9111	“ “ “ “ Stripper.....
128098	9115	“ “ “ “ “ Bracket
1364c	9117	“ “ “ “ “ “
		Screw.....
330b	9118	Thread (under) Take-up Stripper Screw
128081	9131	“ “ “ “ “ “
		Washer.....
128099	9115	Thread (under) Take-up Thread Guard with 220b.....
128100	9115	Thread (under) Take-up Thread Guard Bracket.....

From the library of: Diamond Needle Corp



NO.	PLATE	NAME
1364c	9117	Thread (under) Take-up Thread Guard Bracket Screw.....
1137E	9118	Thread (under) Take-up Thread Guard Hinge Screw.....
128101	9111	Thread (under) Take-up Thread Guard Spring.....
335d	9118	Thread (under) Take-up Thread Guard Spring Screw.....
220d	9117	Thread (under) Take-up Thread Guard Stop Screw.....
128106	9115	Thread (upper) Controller.....
125561	9115	" " " Lever with 50138F.....
54879	9143	Thread (upper) Controller Lever Connection.....
999F	9117	Thread (upper) Controller Lever Connection Hinge Screw (lower).....
999F	9117	Thread (upper) Controller Lever Connection Hinge Screw (upper).....
1700E	9118	Thread (upper) Controller Lever Connection Hinge Screw (upper) Nut.....
125566	9115	Thread (upper) Controller Lever Hinge Stud.....
465c	9702	Thread (upper) Controller Lever Hinge Stud Set Screw.....
125567	9115	Thread (upper) Controller Lever Post with 465c.....
443c	9118	Thread (upper) Controller Lever Post Set Screw.....
50138F	9115	Thread (upper) Controller Set Screw.....
128107	9115	" " " Thread Guide.....
128108	9115	" " " " " Post.....
175F	9102	Thread (upper) Controller Thread Guide Post Set Screw.....
226d	9117	Thread (upper) Controller Thread Guide Screw.....
128109	9115	Thread (upper) Check Spring (left).....
2127	9115	" " " " " Adjusting Plate.....
226d	9117	Thread (upper) Check Spring (left) Adjusting Plate Screw.....
128110	9115	Thread (upper) Check Spring (right).....
128111	9115	" " " " " Adjusting Plate.....
226d	9117	Thread (upper) Check Spring (right) Adjusting Plate Screw.....

NO.	PLATE	NAME
128112	9101	Thread (upper) Check Spring Regulating Stud.....
447c	9118	Thread (upper) Check Spring Regulating Stud Set Screw.....
128324	9702	Thread (upper) Oil Cup with 128325.....
128325	9702	" " " " Pad (felt).....
337j	9131	" " " " Screw.....
125568	9101	" " " Take-up.....
217d	9117	" " " Screw.....
128113	9101	" " " Stripper.....
128114	9101	" " " " Bracket.....
1192d	9117	" " " " " Screw.....
226d	9117	Thread (upper) Take-up Screw.....
128326	9700	Throat Plate with 226d, 128327 and 128328, for 128319, for $\frac{1}{8}$ to $\frac{1}{16}$ in. gauges.....
128327	9700	Throat Plate Tape Guide (left).....
128328	9700	" " " " (right).....
226d	9117	" " " " Screw.....
1319F	9118	" " " Screw.....

## IRON BASE

NO.	PLATE	NAME
128116	9119	Machine Base with 304c, 307c, 418c, 1513j, 27795, two each 935d, 42088, 66707 and three wood screws $1\frac{1}{2}$ in. No. 12.....
42088	9121	Machine Cushion (felt).....
935d	9121	" " Screw.....
66707	9121	" " " Washer.....
304c	9121	" " Screw Centre (left).....
1513j	9121	" " " " Nut.....
307c	9140	" " " " (right).....
448c	9701	" " " " Set Screw.....
27795	9140	" " " " " " Washer.....

## ACCESSORIES

NO.	PLATE	NAME
1107j	5563	Machine Thumb Screw, for 3 in. table..
1108j	5563	" " " " 2 in. table..
14063	9140	" " " Spring.....
9842	9121	" " " " Washer..

## ACCESSORIES

NO.	PLATE	NAME
120344	6375	Oiler (copper plated) with 120345.....
120345	6375	“ Spout, 5 in. long.....
26026	6375	Screw Driver (large).....
26485	6375	“ “ (small).....
120341	6375	Tweezers (curved).....
4822	6375	Wrench for 1521 and 1547.....
8908	6375	“ “ 1664, 1722 and 1723.....
8909	9140	“ “ 1513.....

## BELT GUARD

NO.	PLATE	NAME
128171	9119	Belt Guard (lower).....
128172	9119	“ “ (upper).....
63505	9121	“ “ “ Hinge Pin.....
743382	9121	“ “ “ Lock Spring.....
2273	9121	“ “ “ “ “ Position Pin.....
331b	9118	Belt Guard (upper) Lock Spring Screw.
128173	-----	Belt Guard complete, Nos. 331b, 2273, 63505, 128171, 128172, 743382, and three wood screws 1 in. No. 10.....

## FOOT LIFTER PARTS

NO.	PLATE	NAME
6439	-----	Chain, 36 in. to 45 in., with 56864 and 56865.....
NOTE: When ordering No. 6439 give length required.		
4879	9121	Chain Connecting Link.....
56864	9121	“ Hook (large).....
56865	9121	“ “ (small).....
126249	9137	Treadle.....
4882	9121	“ Shaft.....
126250	9140	“ Spring.....
126251	9137	“ Stand.....
126252	9137	Treadle complete, Nos. 4882, 126249 to 126251 and two wood screws 1 in. No. 16.....

## TAPE HOLDER

(5 IN. DIAM.)

NO.	PLATE	NAME
36795	2116	Tape Holder Body.....
36796	2116	“ “ Cover.....
55d	9701	“ “ “ Hinge Screw.....
28994	2116	Tape Holder (5 in. diam.) complete, for under the bench, Nos. 55d, 36795, 36796 and two wood screws 1¼ in. No. 10.....

## THREAD UNWINDER

FOR FOUR SPOOLS

NO.	PLATE	NAME
225395	8953	Spool Rest (for two spools) with 201018c
225388	8953	“ “ Rod.....
200383c	9140	“ “ “ Set Screw.....
201018c	9140	“ “ “ Set Screw.....
202490	8953	“ Stand with 200383c.....
225391	8953	Thread Guide.....
201696j	9140	“ “ Lock Nut.....
225392	8953	“ “ Rod with 208E and 225393
208E	9117	“ “ “ Screw.....
225393	9140	“ “ “ Washer.....
225398	8953	Thread Unwinder complete, Nos. 201696j, 202490, 225388, 225392, two 225395, four 225391 and three wood screws 7/8 in. No. 12.....
27739	7234	Thread Cone (wood) for large cones....
225390	7234	“ “ Holder, for inverted cones

NOTE: Nos. 27739 and 225390 are used with,  
but not included in 225398

**NUMERICAL LIST OF PARTS**  
**FOR**  
**MACHINE No. 148-6**

**NUMERICAL LIST OF PARTS**

NO. PLATE	NAME
55b 9701	Tape Holder Cover Hinge Screw for 28991
108e 9117	Presser Bar Lifter Connecting Link Hinge Screw (short)
110e 9117	Tension (upper thread) Releasing Shaft Crank Link Hinge Screw
131b 9117	Cylinder Screw
150b 9701	Hand Wheel and Pulley Shaft Screw
152c 9102	Cylinder Rock Shaft Connection Cap (large) Screw for 128918
161c 9117	Presser Bar Lifting Lever Extension Screw
171c 9117	Crank Connecting Rod Cap (upper) Screw for 128267
171c 9117	Cylinder Rock Shaft Connecting Rod Cap (lower) Screw for 125601
171c 9117	Cylinder Rock Shaft Connecting Rod Cap (upper) Screw for 128025
175c 9102	Cylinder Rock Shaft Connection Cap (small) Screw for 128918
175e 9102	Thread (upper) Controller Thread Guide Post Set Screw
176b 9117	Tension (under thread) Bracket Screw
181b 9110	Presser Bar Lifting Lever Stop Screw
185a 9117	Needle Guard Holder Screw
185b 9117	Thread (under) Take-up Knife Holder Screw
190b 9117	Presser Foot Screw
198b 9109	Cylinder Rock Shaft Eccentric Set Screw for 128011
207c 9111	Needle Bar Connecting Stud Clamping Screw for 128117
208e 9117	Thread Unwinder Thread Guide Screw for 225392
217b 9117	Crank Connecting Rod Position Plate Screw for 128261
217b 9117	Cylinder Rock Shaft Connecting Rod Position Plate Screw for 128026
217b 9117	Thread (upper) Take-up Screw
220b 9117	Cylinder Rock Shaft Bushing (front) Set Screw
220b 9117	Needle Bar Thread Retainer Bracket Screw for 128118
220b 9117	Thread (under) Take-up Thread Guard Stop Screw for 128099

NO. PLATE	NAME
224j 9700	Cylinder Tape Guide (back) Screw.....
226d 9117	Thread (upper) Controller Thread Guide Screw.....
226d 9117	Thread (upper) Check Spring (left) Ad- justing Plate Screw.....
226d 9117	Thread (upper) Check Spring (right) Ad- justing Plate Screw.....
226d 9117	Thread (upper) Take-up Stripper Screw
226d 9117	Throat Plate Tape Guide Screw for 128326.....
228d 9702	Thread (under) Protector Screw.....
229d 9117	“ (under) Pull-off Adjusting Screw
233d 9117	Cylinder End Cover Tape Guide Screw for 128311.....
233d 9117	Cylinder Top Cover (front) Spring Screw for 128033.....
233d 9117	Needle Guard (back) Screw.....
233d 9117	“ “ (front) Screw.....
233d 9117	Tension (under thread) Releaser Adjust- ing Screw.....
286d 9118	Arm Side Cover Thumb Screw.....
286d 9118	Face Plate Thumb Screw.....
304c 9121	Machine Screw Centre (left) for 128116.
307c 9140	“ “ “ (right) for 128116
316c 9118	Tension (upper thread) Releasing Shaft Stop Screw.....
330d 9118	Tension (upper thread) Bracket Thread Eyelet Screw.....
330d 9118	Thread (under) Take-up Stripper Screw
331d 9118	Belt Guard (upper) Lock Spring Screw for 128173.....
334d 9118	Thread (under) Nipper Spring Screw...
335d 9118	“ “ Take-up Thread Guard Spring Screw.....
337j 9131	Cylinder Tape Guide (front) Screw.....
337j 9131	Presser Foot Needle Guard Screw for 128321.....
337j 9131	Thread (upper) Oil Cup Screw.....
376d 9118	Tension (upper thread) Bracket Screw..
391d 9118	Cylinder Top Cover (front) Screw for 128309.....
399d 9118	Looper Screw.....
405d 9118	Cylinder End Cover Lock Spring Screw for 128311.....
437c 9118	Arm Rock Shaft Bushing (back) Set Screw.....

NO. PLATE	NAME
440c 9701	Presser Bar (upper) Guide Bracket Set Screw for 128066.....
443c 9118	Thread (upper) Controller Lever Post Set Screw.....
445c 9122	Hand Wheel and Pulley Shaft Flanged Bushings (left) Set Screw.....
447c 9118	Thread (upper) Check Spring Regulating Stud Set Screw for 128079.....
448c 9701	Feed Regulator Pawl Lever Set Screw for 128047.....
448c 9701	Presser Bar Connecting Bracket Set Screw (long) for 128067.....
448c 9701	Machine Screw Centre (right) Set Screw for 128116.....
452c 9122	Feed Lifting Lever Hinge Pin Set Screw for 128309.....
452c 9122	Tension (upper thread) Releasing Shaft Crank Set Screw for 128082.....
453c 9701	Feed Regulator Pawl Set Screw for 128046.....
453c 9701	Presser Bar Connecting Bracket Set Screw (short) for 128067.....
456c 9101	Arm Rock Shaft Collar Set Screw for 54921.....
460c 9118	Cylinder Top Cover (back) Hinge Pin Set Screw for 128309.....
462c 9118	Feed Lifting Eccentric Set Screw for 128042.....
465c 9702	Thread (under) Nipper Cam Set Screw for 128086.....
465c 9702	Thread (under) Take-up Knife Set Screw for 128247.....
465c 9702	Thread (under) Take-up Set Screw for 128096.....
465c 9702	Thread (upper) Controller Lever Hinge Stud Set Screw for 125567.....
563c 9118	Needle Bar Bushing (lower) Set Screw..
563c 9118	“ “ “ (upper) Set Screw..
563c 9118	Presser Bar (lower) Bushing Set Screw..
620c 9118	Thread (under) Eyelet Set Screw.....
621d 9118	Face Plate Thread Guide Screw for 128318.....
726d 9102	Thread (under) Separator Thread Re- tainer Screw for 128166.....
811e 9700	Cylinder Tape Guide (back) Roller Screw for 128314.....
866d 9117	Presser Bar Lifting Lever Hinge Screw..

NO.	PLATE	NAME
888c	9118	Arm Rock Shaft Bushing (front) Set Screw.....
888c	9118	Hand Wheel and Pulley Shaft Bushing (right) Set Screw.....
896E	9117	Crank Connecting Rod Cap (lower) Screw for 54616.....
896E	9117	Feed Connecting Rod Cap Screw for 128038.....
896E	9117	Feed Lifting Lever Connecting Rod Cap Screw for 54953.....
911E	9101	Arm Back Cover Latch Screw Stud for 54915.....
935D	9121	Machine Cushion Screw for 128116.....
999F	9117	Thread (upper) Controller Lever Connection Hinge Screw (lower).....
999F	9117	Thread (upper) Controller Lever Connection Hinge Screw (upper).....
1125c	9118	Cylinder Rock Shaft Bushing (back) Set Screw.....
1131c	9117	Tension Releasing Arm Hinge Screw.....
1137E	9118	Thread (under) Take-up Thread Guard Hinge Screw.....
1143c	9109	Feed Eccentric Body Set Screw for 128174.....
1144D	9117	Tension (under thread) Releasing Lever Spring Screw.....
1149D	9702	Thread (under) Take-up Frame Screw ..
1231L	9118	Cylinder End Cover Slide (front) Screw for 128311.....
1253C	9102	Cylinder Rock Shaft Crank Set Screw for 128017.....
1302D	9118	Cylinder Thread Guard Screw.....
1319F	9118	Throat Plate Screw.....
1332D	9117	Needle Bar Thread Retainer Spring Screw for 128118.....
1364c	9117	Thread (under) Take-up Stripper Bracket Screw.....
1364c	9117	Thread (under) Take-up Thread Guard Bracket Screw.....
1402D	9117	Cylinder Thread Eyelet Screw.....
1407J	5563	Machine Thumb Screw, for 3 in. table (Accessories).....
1408J	5563	Machine Thumb Screw, for 2 in. table (Accessories).....
1443D	9101	Arm Back Cover Spring Screw for 54914
1454c	9110	Looper (back) Carrier Clamping Screw for 128059.....

NO.	PLATE	NAME
1454c	9110	Looper (front) Carrier Clamping Screw for 128061.....
1477D	9701	Cylinder End Cover Cap Screw for 128311.....
1492D	9117	Thread (upper) Take-up Stripper Bracket Screw.....
1498F	9114	Needle Set Screw for 54847.....
1513J	9121	Machine Screw Centre (left) Nut for 128116.....
1520J	9118	Needle Bar Connecting Link Hinge Stud Nut.....
1521E	9118	Tension Releasing Arm Connecting Rod Nut.....
1538D	9101	Arm Back Cover Latch Screw Stud Thumb Nut for 54914.....
1543W	9118	Pressure Regulating Thumb Screw Lock Nut.....
1547J	9118	Tension (upper thread) Releasing Shaft Stop Screw Nut.....
1597E	9118	Crank Connecting Rod Ball Screw Stud Nut.....
1597E	9118	Cylinder Rock Shaft Connecting Rod Ball Screw Stud (upper) Nut.....
1664E	9118	Cylinder Rock Shaft Connecting Rod Ball Screw Stud (lower) Nut.....
1700E	9118	Thread (upper) Controller Lever Connection Hinge Screw (upper) Nut.....
1722E	9122	Crank Connecting Rod Nut (lower) for 128264.....
1722E	9122	Cylinder Rock Shaft Connecting Rod Nut (lower) for 128021.....
1722E	9122	Feed Lifting Lever Connecting Rod Hinge Screw Nut.....
1723E	9122	Crank Connecting Rod Nut (upper) for 128264.....
1723E	9122	Cylinder Rock Shaft Connecting Rod Nut (upper) for 128021.....
1735J	9118	Feed Adjusting Screw Nut.....
1735J	9118	" Rod Connecting Link Hinge Screw Nut.....
2049	9140	Presser Bar Lifter Stop Pin (upper).....
2102	9131	Tension (under thread) Disc.....
2102	9131	" (upper thread) Disc.....
2127	9145	Thread (upper) Check Spring (left) Adjusting Plate.....
2269	9110	Presser Bar Lifter Stop Pin (lower).....

NO.	PLATE	NAME
2273	9121	Belt Guard (upper) Lock Spring Position for 128173.....
4822	6375	Wrench for 1521 and 1547 (Accessories).....
4879	9121	Chain Connecting Link.....
4882	9121	Treadle Shaft for 126252.....
6439	—	Chain, 36 in. to 45 in., with 56864 and 56865.....
8908	6375	Wrench for 1664, 1722 and 1723 (Accessories).....
8909	9140	Wrench for 1513 (Accessories).....
9842	9121	Machine Thumb Screw Spring Washer (Accessories).....
14063	9140	Machine Thumb Screw Spring (Accessories).....
17547	9131	Tension (under thread) Thread Guide.....
17547	9131	“ (upper thread) Thread Guide.....
26026	6375	Screw Driver large (Accessories).....
26276	9121	Presser Foot Hinge Pin for 128321.....
26485	6375	Screw Driver, small (Accessories).....
27739	7234	Thread Unwinder Thread Cone (wood) for large cones.....
27795	9140	Machine Screw Centre (right) Set Screw Washer for 128116.....
28994	2116	Tape Holder (5 in. diam.) complete, for under the bench Nos. 55b, 36795, 36796 and two wood screws 1 1/4 in. No. 10.....
32572	9131	Tension (under thread) Releasing Disc.....
32572	9131	“ (upper thread) Releasing Disc.....
36795	2116	Tape Holder Body for 28994.....
36796	2116	“ “ Cover for 28994.....
41128	9111	Hand Wheel and Pulley Shaft Bushing (right) Oil Pad (braided cotton).....
42088	9121	Machine Cushion (felt) for 128116.....
42365	9111	Hand Wheel and Pulley Shaft Flanged Bushing (left) Oil Pad (braided cotton).....
42833	9102	Feed Regulator Pawl Lever Stud Spring.....
46111	9102	Face Plate Pin.....
46478	9111	Needle Clamp Thread Guide for 54847.....
50076b	9117	Tension (under thread) Releaser Hinge Screw.....
50083c	9701	Arm Rock Shaft Crank (back) Set Screw for 128006 and 128262.....
50084c	9122	Hand Wheel and Pulley Set Screw for 128335.....
50116F	9117	Presser Bar Lifter Connecting Link Hinge Screw (long).....

NO.	PLATE	NAME
50128c	9117	Feed Dog Screw.....
50132w	9118	Pressure Regulating Thumb Screw.....
50135c	9701	Arm Rock Shaft Crank (front) Set Screw for 128007.....
50138F	9115	Thread (upper) Controller Set Screw for 125561.....
50150c	9701	Feed Rod Hinge Bracket Hinge Pin Set Screw for 128309.....
50150c	9701	Feed Rod Hinge Pin Set Screw for 128053.....
50150c	9701	Thread (under) Take-up Frame Cover Hinge Pin Set Screw for 128299.....
50223b	9117	Arm Back Cover Latch Hinge Screw for 54941.....
50224c	9118	Arm Rock Shaft Bushing (intermediate) Set Screw.....
50326c	9131	Tension (under thread) Screw Stud for 59539.....
50326c	9131	Tension (upper thread) Screw Stud for 59539.....
50415c	9117	Presser Bar Lifter Hinge Screw.....
50589c	9109	Cylinder Rock Shaft Eccentric Regulating Screw for 128041.....
50730c	9102	Cylinder Rock Shaft Connecting Rod Ball Screw Stud (lower) for 128025.....
50731c	9102	Cylinder Rock Shaft Connecting Rod Ball Screw Stud (upper) for 128026.....
50732c	9117	Feed Adjusting Screw (eccentric).....
50733c	9117	“ Rod Connecting Link Hinge Screw.....
50997c	9117	“ Lifting Lever Connecting Rod Hinge Screw (eccentric).....
50999c	9117	Cylinder End Cover Slide (back) Stop Screw.....
51043c	9122	Crank Connecting Rod Ball Screw Stud for 128267.....
51570c	9131	Tension (under thread) Regulating Thumb Nut for 59539.....
51570c	9131	Tension (upper thread) Regulating Thumb Nut for 59539.....
51818	9701	Tension Releasing Arm Roller and Screw Stud for 128083.....
*54612	—	Crank Connecting Rod Cap (lower) for 54616.....
*54613	—	Cylinder Rock Shaft Connecting Rod Cap (upper) for 125601.....
*54614	—	Crank Connecting Rod End Bearing (lower) for 54616.....

NO.	PLATE	NAME
*54616	----	Crank Connecting Rod Head (lower); Nos. 54612, 54614 and two 896e, for 128264 and 128340.
54620	9101	Cylinder Dowel Pin.
*54625	----	“ End Cover Slide (back) for 128128.
54627	9102	Cylinder End Cover Slide (front) Hinge Pin for 128128.
54664	9109	Cylinder Top Cover (back) Hinge Pin for 128309.
54708	9112	Needle Bar (hollow) for 54846.
54710	9111	“ “ Bushing (lower).
54710	9111	“ “ “ (upper).
*54711	9111	“ “ Connecting Link for 128126.
54712	9110	“ “ “ “ Hinge Stud for 128126.
54716	9111	Needle Bar Thread Retainer Spring for 128118.
54722	9111	Presser Bar Spring Stud.
54819	----	“ Foot Shank for 128321.
54846	-----	Needle Bar complete, Nos. 54708 and 54847.
54847	9111	Needle Clamp with 46478 and two 4498e, for 54846.
54873	9702	Tension (upper thread) Releasing Shaft Crank Link.
54879	9143	Thread (upper) Controller Lever Connection.
54897	9101	Arm Oil Cup.
54913	9119	“ Back Cover for 54914.
54914	-----	Arm Back Cover complete, Nos. 1538b, 50223b, 54913, 54915, 54916 and two 1443b.
54915	9101	Arm Back Cover Latch with 911e, for 54914.
54916	9101	Arm Back Cover Spring for 54914.
54919	9101	“ Rock Shaft Bushing (intermediate).
54921	9101	“ “ “ Collar with two 456e.
*54925	----	Crank Connecting Rod (rod only) for 128264.
54940	-----	Feed Lifting Lever Connecting Rod Cap for 54953.
54953	9109	Feed Lifting Lever Connecting Rod with 54940 and two 896e, for 128122.
54958	9102	Feed Regulator Friction Spring.
54968	9112	Hand Wheel and Pulley Shaft Bushing (right).

NO.	PLATE	NAME
54970	9101	Hand Wheel and Pulley Shaft Washer.
54977	9111	Needle Guard Holder.
54989	9702	Tension (upper thread) Releasing Shaft
*55032	----	Cylinder Rock Shaft Connecting Rod End Bearing (upper) for 125601.
55034	9101	Crank Connecting Rod Position Plate for 128264.
55034	9101	Cylinder Rock Shaft Connecting Rod Position Plate for 128026.
55084	9110	Presser Bar (lower).
*55165	----	Cylinder End Cover Slide (front) for 128128.
55184	9101	Face Plate Thread Guide for 128318.
56016	9150	Arm Side Cover.
56864	9121	Chain Hook (large) for 6439.
56865	9121	“ “ (small) for 6439.
59534	9131	Tension (under thread) Spring.
59536	9131	“ (upper thread) Spring.
59537	9131	“ (under thread) Spring Bushing (large).
59537	9131	Tension (upper thread) Spring Bushing (large).
59538	9131	Tension (under thread) Spring Bushing (small).
59538	9131	Tension (upper thread) Spring Bushing (small).
59539	----	Tension (under thread) Screw Stud 50326e with 51570e.
59539	----	Tension (upper thread) Screw Stud 50326e with 51570e.
61121	9115	Thread (under) Pull-off Position Pin for 128086.
63505	9121	Belt Guard (upper) Hinge Pin for 128173.
63824	9131	Tension (under thread) Releasing Lever Spring.
66707	9121	Machine Cushion Screw Washer for 128116.
67425	9122	Crank Connecting Rod Ball Screw Stud Nut Lock Washer.
120344	6375	Tweezers, curved (Accessories).
120344	6375	Oiler (copper plated) with 120345 (Accessories).
120345	6375	Oiler Spout, 5 in. long, for 120344.
125561	9115	Thread (upper) Controller Lever with 50138e.
125566	9115	Thread (upper) Controller Lever Hinge Stud.

NO.	PLATE	NAME
125567	9115	Thread (upper) Controller Lever Post with 465c.....
125568	9101	Thread (upper) Take-up.....
125601	----	Cylinder Rock Shaft Connecting Rod End Bearing (upper) 55032 with 54613 and two 171e, for 128026.....
		Nos. 126249 to 126251 for 126252
126249	9137	Treadle.....
126250	9140	" Spring.....
126251	9137	" Stand.....
126252	9137	Treadle complete, Nos. 4882, 126249 to 126251 and two wood screws 1 in. No. 16.....
*128001	----	Arm.....
128002	9119	" Rock Shaft.....
128003	9101	" " " Bushing (back).....
128004	9101	" " " " (front).....
128006	9122	" " " Crank (back) with two 50083c, for 128021.....
128007	9109	Arm Rock Shaft Crank (front) with two 50135c.....
128013	9101	Cylinder End Cover Lock Spring for 128311.....
128014	9150	Cylinder Rock Shaft for 128124.....
128015	9102	" " " Bushing (back).....
128016	9102	" " " " (front).....
128017	9102	" " " Crank with two 1253c.....
128018	9102	Cylinder Rock Shaft Connection with 128019, 128020 and two each 152n and 175e, for 128124.....
*128019	----	Cylinder Rock Shaft Connection Cap (large) for 128018.....
*128020	----	Cylinder Rock Shaft Connection Cap (small) for 128018.....
128021	9150	Cylinder Rock Shaft Connecting Rod complete, Nos. 1722e, 1723e, 128022, 128025 and 128026.....
128022	----	Cylinder Rock Shaft Connecting Rod (rod only) for 128021.....
*128023	----	Cylinder Rock Shaft Connecting Rod Cap (lower) for 128025.....
*128024	----	Cylinder Rock Shaft Connecting Rod End Bearing (lower) for 128025.....

NO.	PLATE	NAME
128025	----	Cylinder Rock Shaft Connecting Rod Head (lower) Nos. 50730c, 128023, 128024 and two 171e, for 128021.....
128026	----	Cylinder Rock Shaft Connecting Rod Head (upper) Nos. 217b, 50731e, 55034 and 125601, for 128021.....
128027	----	Cylinder Rock Shaft Eccentric for 128041
128028	9102	" Thread Eyelet for 128139.....
128030	9102	" " Guard.....
128031	9103	" " Tube.....
128032	9103	" Top Cover (back) for 128309.....
128033	9103	" " " (front) with 233b and 128034, for 128309.....
128034	9109	Cylinder Top Cover (front) Spring for 128033.....
128038	9112	Feed Connecting Rod with 128039 and two 896e, for 128124.....
*128039	----	Feed Connecting Rod Cap for 128038.....
*128040	----	" Eccentric for 128041.....
128041	9109	Feed Eccentric (adjustable) complete, Nos. 198b, 50589c, 128027, 128040 and 128174.....
128042	9109	Feed Lifting Eccentric with two 462c, for 128122.....
128043	9112	Feed Lifting Lever.....
128044	9102	" " " Hinge Pin.....
128045	9109	" Regulator for 128125.....
128046	9109	" " Pawl with two 453c.....
128047	9150	" " " Lever with 448c.....
128048	9102	" " " Stud.....
128049	9102	" " " Shaft.....
128050	9112	" Rod.....
128051	9102	" " Connecting Link (left).....
128052	9102	" " " " (right).....
128053	9111	" " Hinge Bracket with 50150c.....
128054	9111	" " " " Hinge Pin.....
128055	9102	" " " Pin.....
128058	9110	Looper (back).....
128059	9110	" " Carrier with 1453c.....
128060	9110	" (front).....
128061	9110	" " Carrier with 1454c.....
128062	9111	Needle Guard (back) for 1/4 in. gauge and below.....
128063	9111	Needle Guard (front) for 1/4 in. gauge and below.....
128064	9111	Presser Bar (lower) Bushing.....
128065	9150	" " (upper).....



NO.	PLATE	NAME
128066	9110	Presser Bar (upper) Guide Bracket with 440c.....
128067	9701	Presser Bar Connecting Bracket with 448c and 453c.....
128068	9110	Presser Bar Lifter.....
128069	9110	“ “ “ Connecting Link.....
128070	9103	“ “ “ Lifting Lever.....
128071	9112	“ “ “ “ Extension.....
128072	9103	“ “ “ Spring (flat).....
128075	9110	Tension (under thread) Bracket.....
128076	9701	“ “ “ Releaser.....
128077	9103	“ “ “ Releasing Lever.....
128078	9131	“ “ “ “ Pin.....
128078	9131	“ (upper thread) Releasing Pin.....
128079	9103	“ “ “ Bracket with two 447c.....
128080	9701	Tension (upper thread) Bracket Thread Eyelet (double).....
128081	9131	Tension (upper thread) Bracket Thread Eyelet Screw Washer.....
128081	9131	Thread (under) Take-up Stripper Screw Washer.....
128082	9702	Tension (upper thread) Releasing Shaft Crank with 452c.....
128083	9143	Tension Releasing Arm with 51818.....
128084	9143	“ “ “ Connecting Rod.....
128085	9110	Thread (under) Eyelet.....
128086	9702	“ “ “ Nipper Cam with 61121 and two 465c.....
128087	-----	Thread (under) Nipper Cam Oil Pad (felt) for 128089.....
128088	-----	Thread (under) Nipper Cam Oil Pad Holder for 128089.....
128089	9110	Thread (under) Nipper Cam Oil Pad Holder 128088 with 128087.....
128090	9110	Thread (under) Nipper Spring (lower).....
128091	9702	“ “ “ “ (upper).....
128092	9115	“ “ “ Pull-off.....
128094	9102	“ “ “ Separator Thread Retainer (right) for 128166.....
128095	9102	Thread (under) Separator Thread Guide for 128166.....
128096	9115	Thread (under) Take-up with two 465c.....
128097	9111	“ “ “ Stripper.....
128098	9115	“ “ “ “ Bracket.....
128099	9115	“ “ “ “ Thread Guard with 220b.....

NO.	PLATE	NAME
128100	9115	Thread (under) Take-up Thread Guard Bracket.....
128101	9111	Thread (under) Take-up Thread Guard Spring.....
128105	9115	Thread (under) Take-up Frame Cover Hinge Pin for 128298.....
128106	9115	Thread (upper) Controller.....
128107	9115	“ “ “ “ Thread Guide.....
128108	9115	“ “ “ “ “ “ Post.....
128109	9115	Thread (upper) Check Spring (left).....
128110	9115	“ “ “ “ “ (right).....
128111	9115	“ “ “ “ “ “ Ad-justing Plate.....
128112	9101	Thread (upper) Check Spring Regulating Stud.....
128113	9101	Thread (upper) Take-up Stripper.....
128114	9101	“ “ “ “ “ Bracket.....
128116	9119	Machine Base with 301c, 307c, 448c, 1513c, 27795, two each 935d, 42088, 66707 and three wood screws 1½ in. No. 42.....
128117	9111	Needle Bar Connecting Stud with 207c, for 128118.....
128118	-----	Needle Bar Connecting Stud complete for 128126, Nos. 220b, 1332b, 54716, 128117, 128119 and 128120.....
128119	9111	Needle Bar Thread Retainer for 128118.....
128120	9701	“ “ “ “ Bracket for 128118.....
128122	-----	Feed Lifting Eccentric 128012 with 51953, for 128125.....
*128124	-----	Cylinder Rock Shaft 128018 with 128014, 128038 and 128041, for 128125.....
128125	-----	Hand Wheel and Pulley Shaft 128340 with 128045, 128122 and 128124.....
128126	-----	Needle Bar Connecting Link 54711 with 54712 and 128118.....
128128	9102	Cylinder End Cover Slide (back) 54625 with 54627 and 55165, for 128311.....
128139	-----	Cylinder Thread Eyelet 128028 with 128166.....
128165	9702	Tension (upper thread) Releasing Shaft Spring.....
128166	9102	Thread (under) Separator with 128094, 128095, 128167 and two 726b.....

NO.	PLATE	NAME
128167	9102	Thread (under) Separator Thread Retainer (left) for 128166.....
128171	9119	Belt Guard (lower) for 128173.....
128172	9119	“ “ (upper) for 128173.....
128173	----	Belt Guard complete, Nos. 331b, 2273, 63505, 128171, 128172, 743382 and three wood screws 1 in. No. 10.....
*128174	----	Feed Eccentric Body with two 1143c, for 128041.....
128238	9702	Thread (under) Protector.....
*128243	9143	“ “ Take-up Frame for 128298.....
128246	9702	“ “ Take-up Knife.....
128247	9702	“ “ “ “ Holder with 465c.....
128256	9701	Needle Guard (back) for $\frac{3}{32}$ in. and $\frac{1}{16}$ in. gauges.....
128257	9701	Needle Guard (front) for $\frac{9}{32}$ in. and $\frac{5}{16}$ in. gauges.....
128262	9122	Arm Rock Shaft Crank (back) with two 50083c, for 128264.....
128264	9150	Crank Connecting Rod complete, Nos. 217b, 1722b, 1723b, 54616, 54925, 55034 and 128267.....
*128265	----	Crank Connecting Rod Cap (upper) for 128267.....
*128266	----	Crank Connecting Rod End Bearing (upper) for 128267.....
*128267	----	Crank Connecting Rod Head (upper) Nos. 51043c, 128265, 128266 and two 171E, for 128264.....
128298	----	Thread (under) Take-up Frame complete, Nos. 128105, 128243 and 128299.....
*128299	9143	Thread (under) Take-up Frame Cover with 50150c, for 128298.....
*128309	----	Cylinder with 452c, 460c, 50150c, 54664, 128032, 128033 and two 391b.....
128310	9150	Cylinder End Cover for 128311.....
128311	----	Cylinder End Cover complete, Nos. 128128, 128310, 128312, two 233b, 1477b, 128013, 128313, three 1231b and four 405d.....
128312	9701	Cylinder End Cover Cap for 128311.....
128313	9700	“ “ “ Tape Guide for 128311.....
128314	9700	Cylinder Tape Guide (back) with 811F and 128315.....

NO.	PLATE	NAME
128315	9700	Cylinder Tape Guide (back) Roller for 128314.....
128316	9700	Cylinder Tape Guide (front).....
128317	9150	Face Plate for 128318.....
128318	----	Face Plate complete, Nos. 621b, 55184 and 128317.....
128319	9700	Feed Dog, 16 teeth (18 teeth to the inch)
128320	----	Presser Foot Plate for 128321.....
128321	9700	Presser Foot (hinged) complete, for $\frac{1}{8}$ in. to $\frac{5}{16}$ in. gauges, Nos. 26276, 54819, 128320 and two each 337a and 128322
128322	9700	Presser Foot Needle Guard for 128321..
128324	9702	Thread (upper) Oil Cup with 128325..
128325	9702	“ “ “ “ Pad (felt) for 128324.....
128326	9700	Throat Plate with 226b, 128327 and 128328, for 128319, for $\frac{1}{8}$ to $\frac{5}{16}$ in. gauges.....
128327	9700	Throat Plate Tape Guide (left) for 128326
128328	9700	“ “ “ “ (right) for 128326
*128331	----	Hand Wheel for 128335.....
128335	9137	Hand Wheel and Pulley complete, Nos. 128334, 128337 and two 50081c.....
128336	9143	Hand Wheel and Pulley Shaft for 128340
*128337	----	Pulley, 27 $\frac{3}{8}$ diam., for 128335.....
128340	----	Hand Wheel and Pulley Shaft 128336 with 54616, for 128125.....
128388	9701	Hand Wheel and Pulley Shaft Flanged Bushing (left).....
200383c	9140	Thread Unwinder Spool Rest Rod Set Screw for 202490.....
201018c	9140	Thread Unwinder Spool Rest Set Screw for 225395.....
201696a	9140	Thread Unwinder Thread Guide Lock Nut for 225398.....
202490	8953	Thread Unwinder Spool Stand with 200383c, for 225398.....
225388	8953	Thread Unwinder Spool Rest Rod for 225398.....
		Nos. 225390 to 225392 for 225398
225390	7234	Thread Cone Holder, for inverted cones
225391	8953	Thread Unwinder Thread Guide.....
225392	8953	“ “ “ “ Rod with 208b and 225393.....
225393	9140	Thread Unwinder Thread Guide Rod Washer for 225392.....

## NUMERICAL LIST OF PARTS

NO.	PLATE	NAME
225395	8953	Thread Unwinder Spool Rest (for two spools) with 201018c, for 225398. . . . .
225398	8953	Thread Unwinder complete, for Four Spools Nos. 201696t, 202490, 225388, 225392, two 225395, four 225391 and three wood screws $\frac{7}{8}$ in. No. 12. . . . .
743382	9121	Belt Guard (upper) Lock Spring for 128173. . . . .

Genuine Singer Needles and their Containers are marked with the Company's Trade Mark "SIMANCO." 1

Needles in Containers marked "For Singer Machines" are not Singer made needles. 2

**ILLUSTRATIONS OF PARTS  
FOR  
MACHINE No. 148-6**

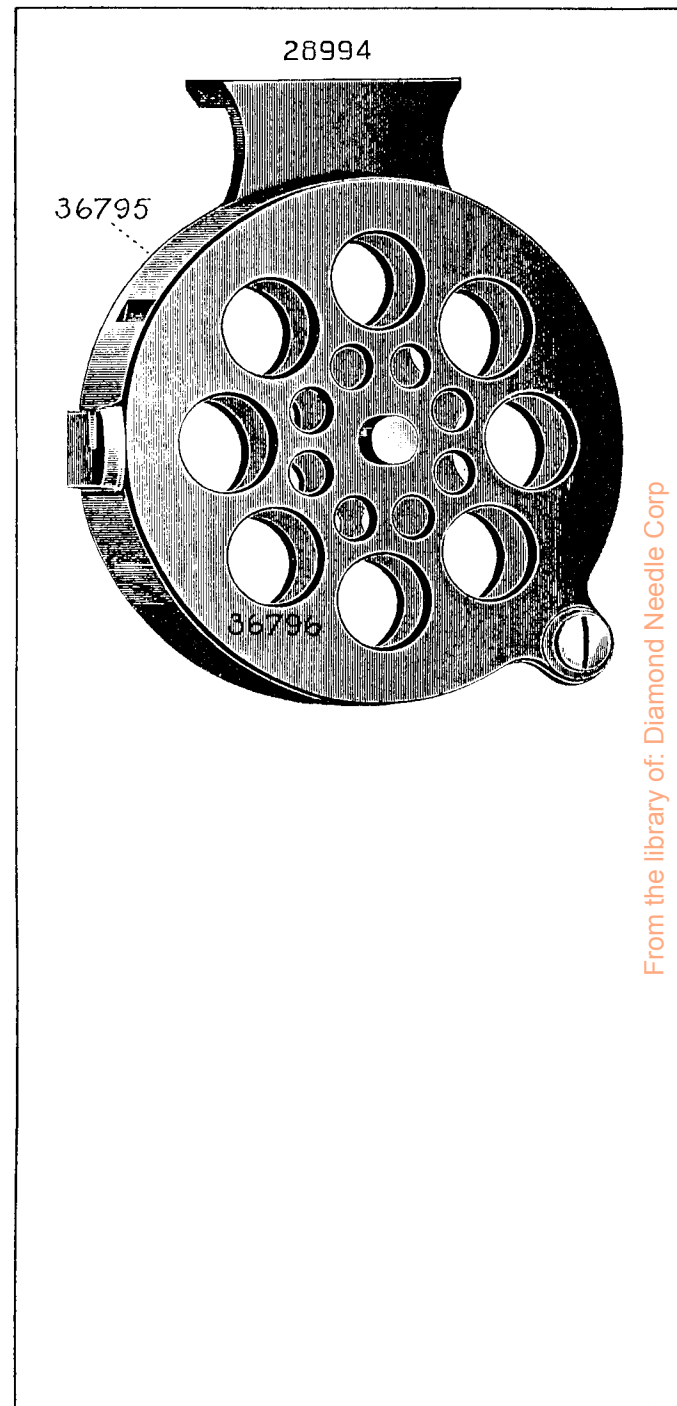


PLATE 5563—FULL SIZE

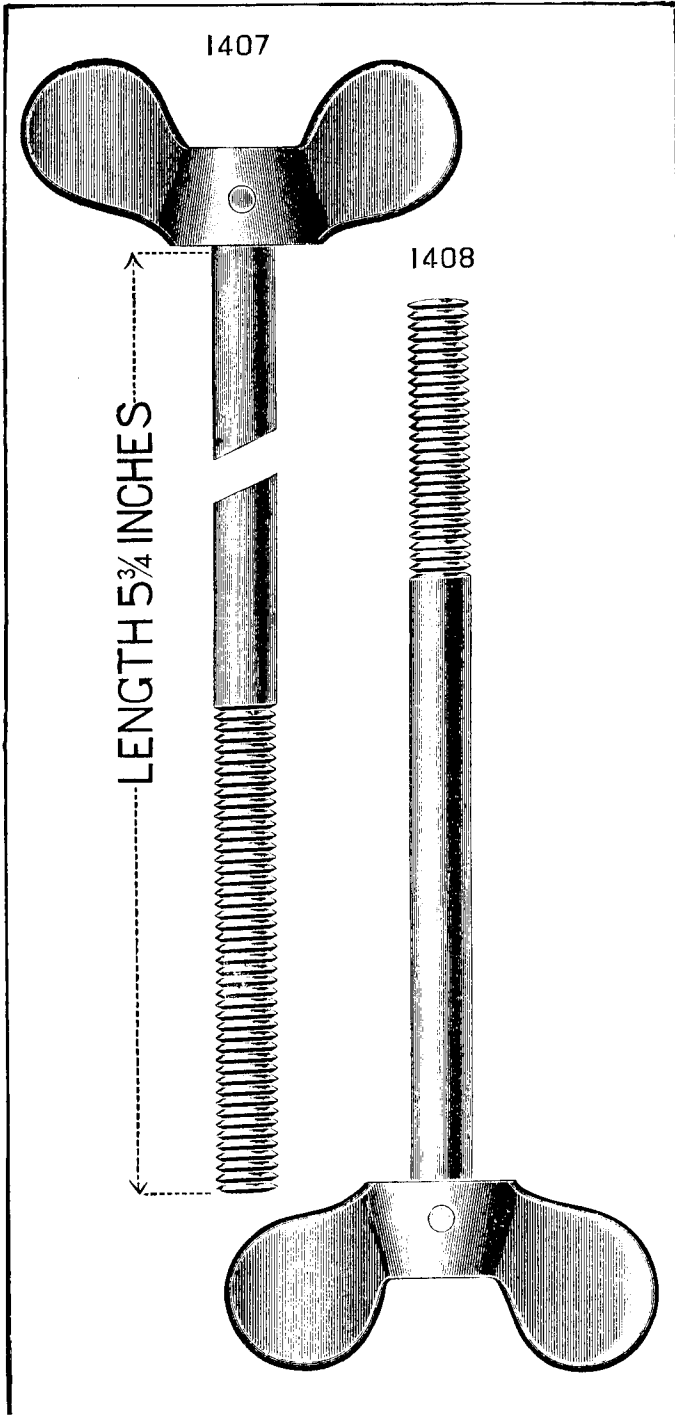


PLATE 6375—ONE-HALF SIZE

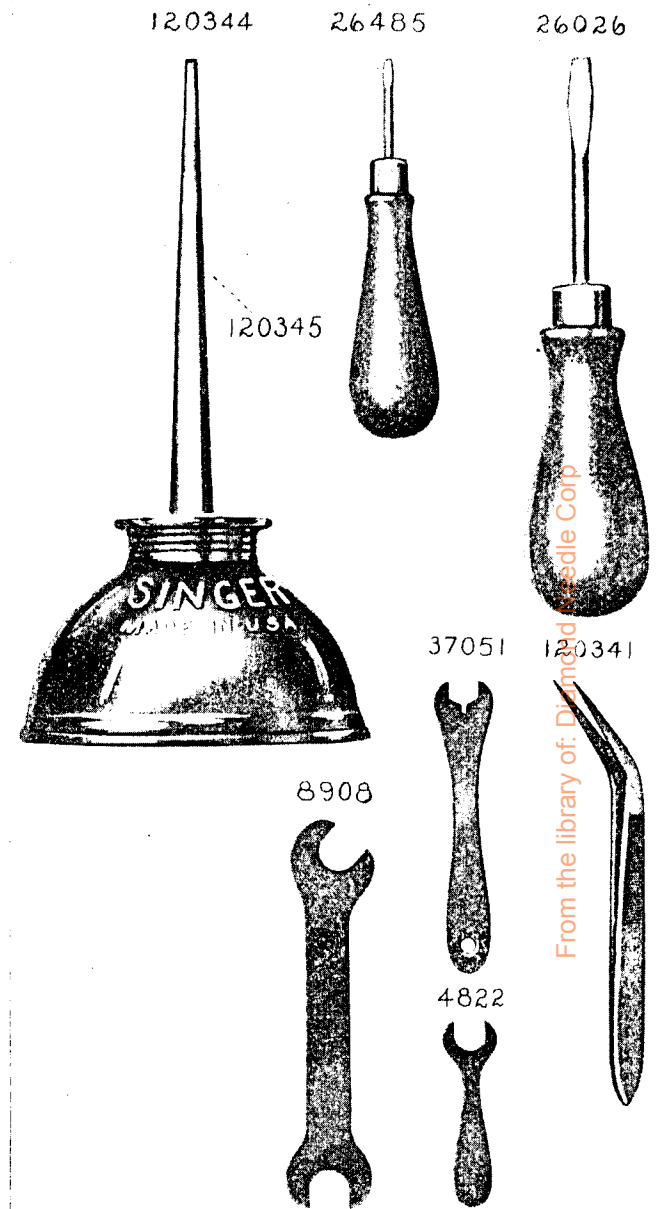
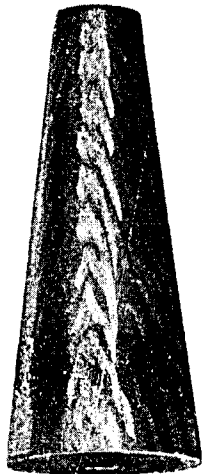


PLATE 7234—ONE-HALF SIZE

27739



225390

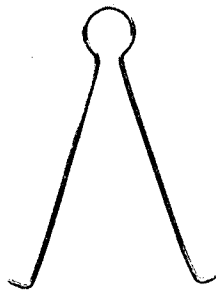
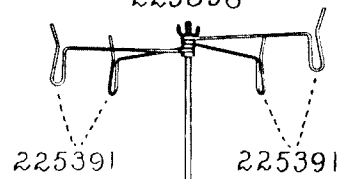


PLATE 8953—ONE-SIXTH SIZE

225398



225391

225391

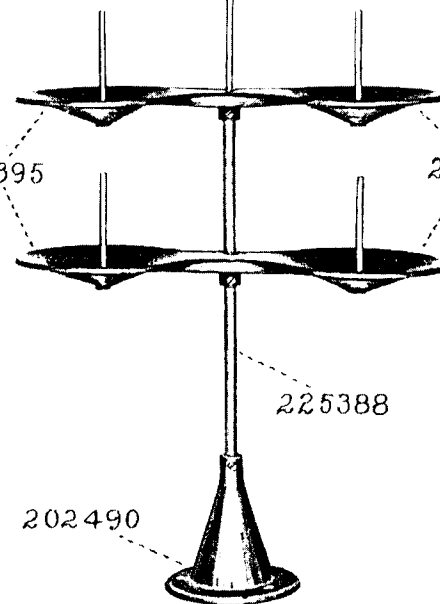
225392

225395

225395

225388

202490



From the library of: Diamond Needle Corp

PLATE 9101—FULL SIZE

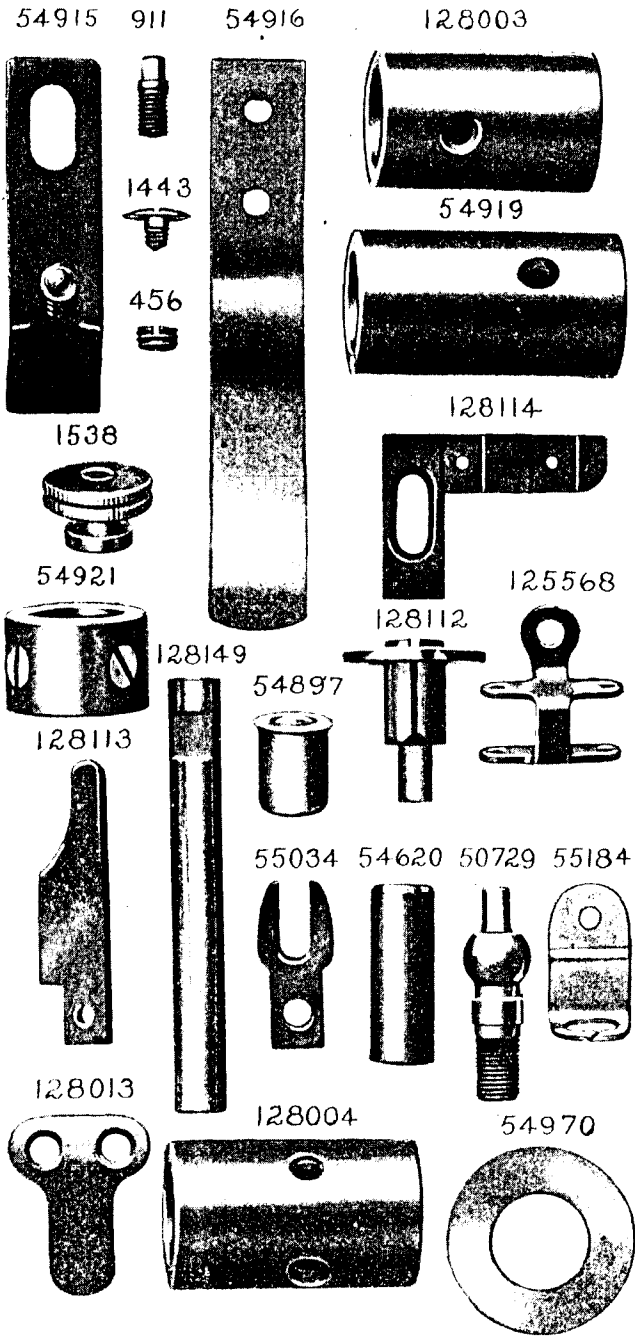


PLATE 9102—FULL SIZE

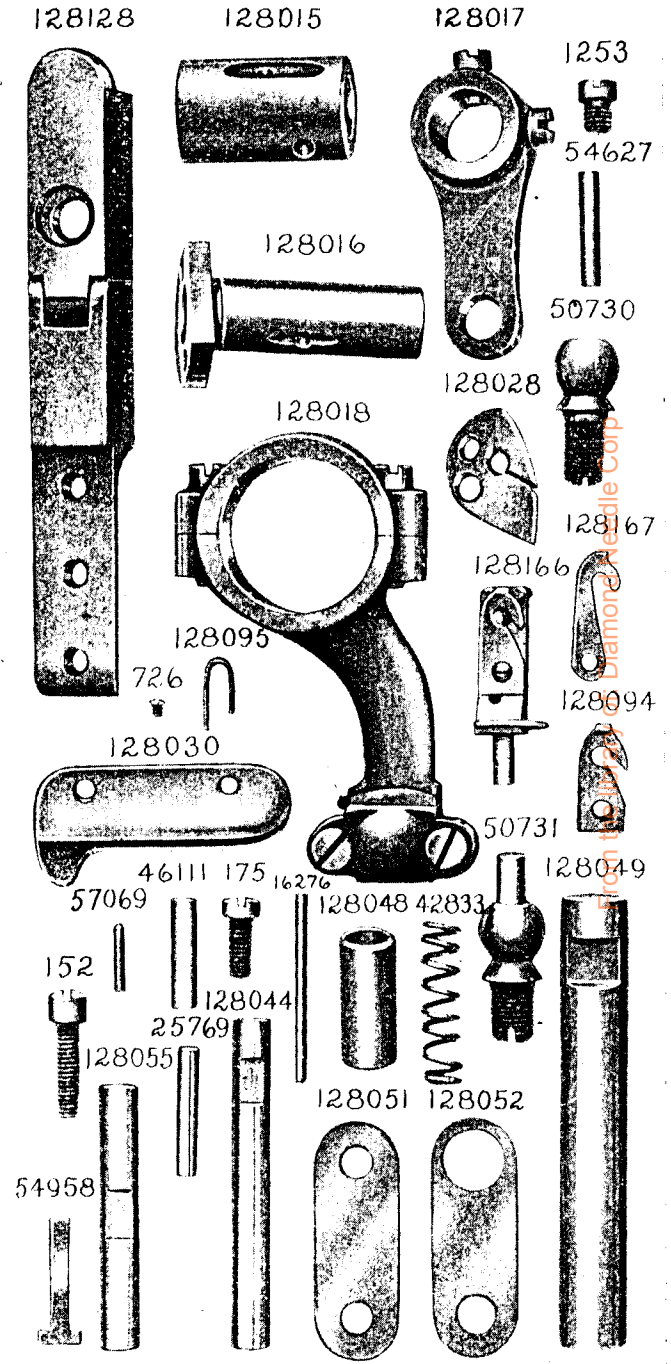
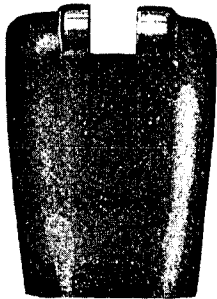


PLATE 9103—ONE-HALF SIZE

128031



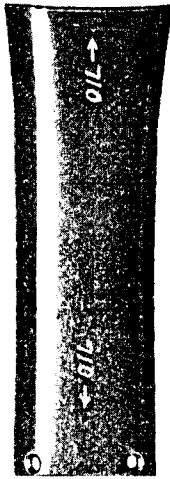
128032



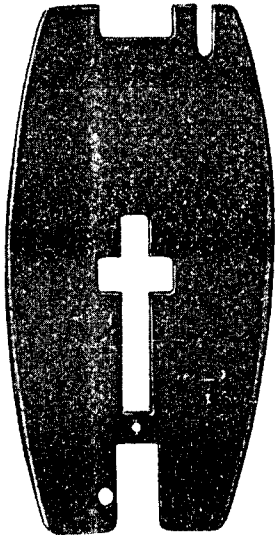
128072



128033



128035



128070



128077



128079

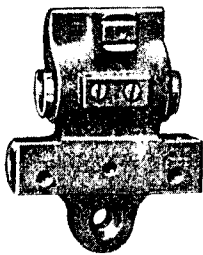
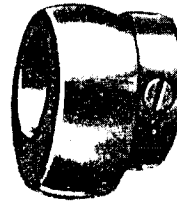
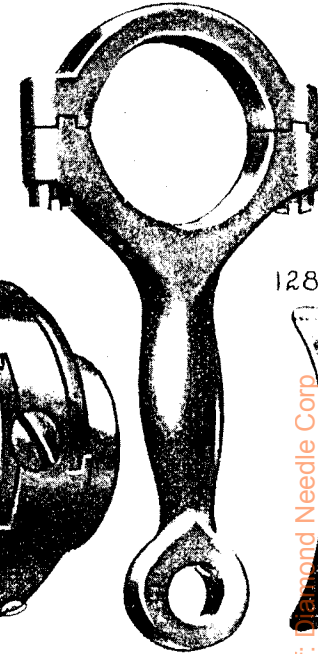


PLATE 9109—FULL SIZE

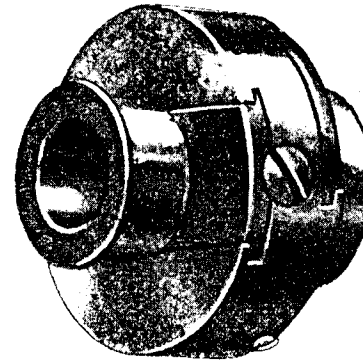
128042



54953



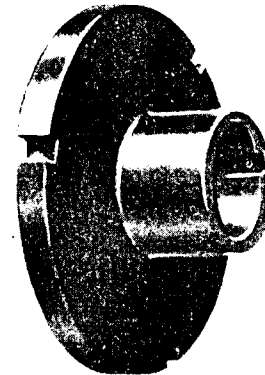
128041



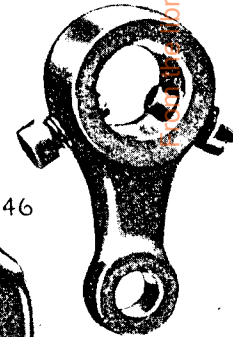
128034



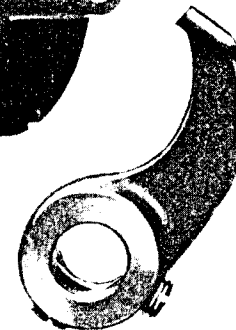
128045



128007



128046



54664

198



1143



50589



Library of: Diamond Needle Corp



PLATE 9110—FULL SIZE

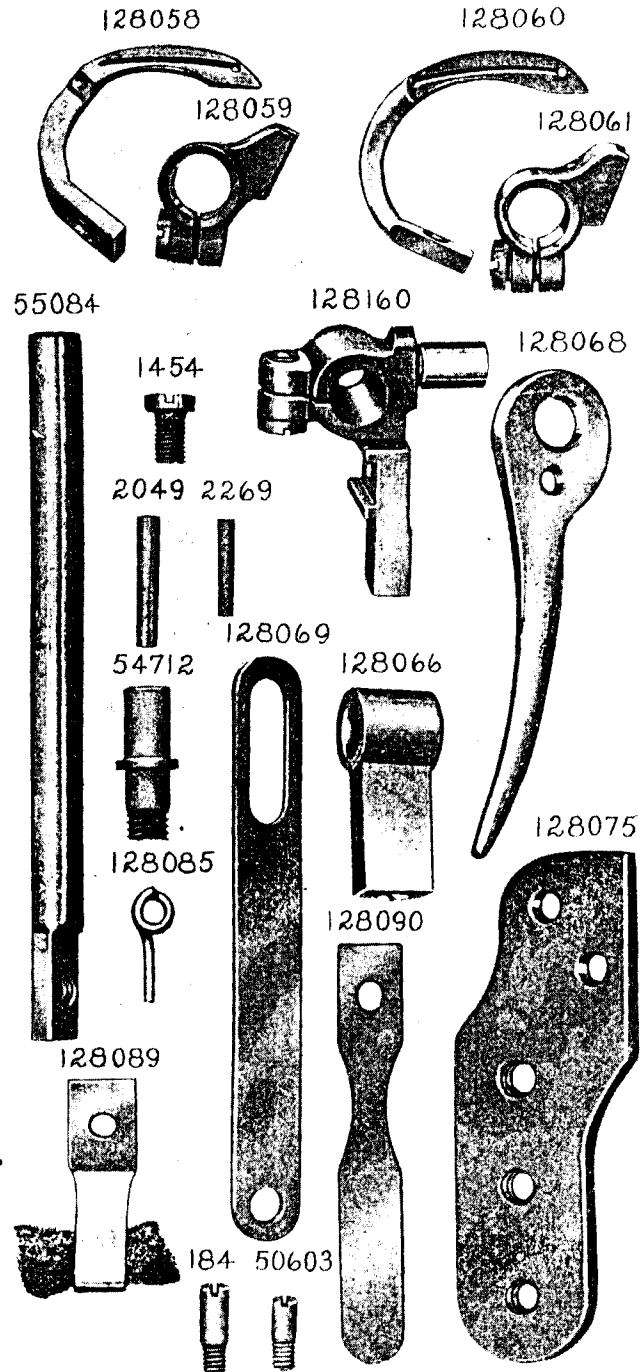


PLATE 9111—FULL SIZE

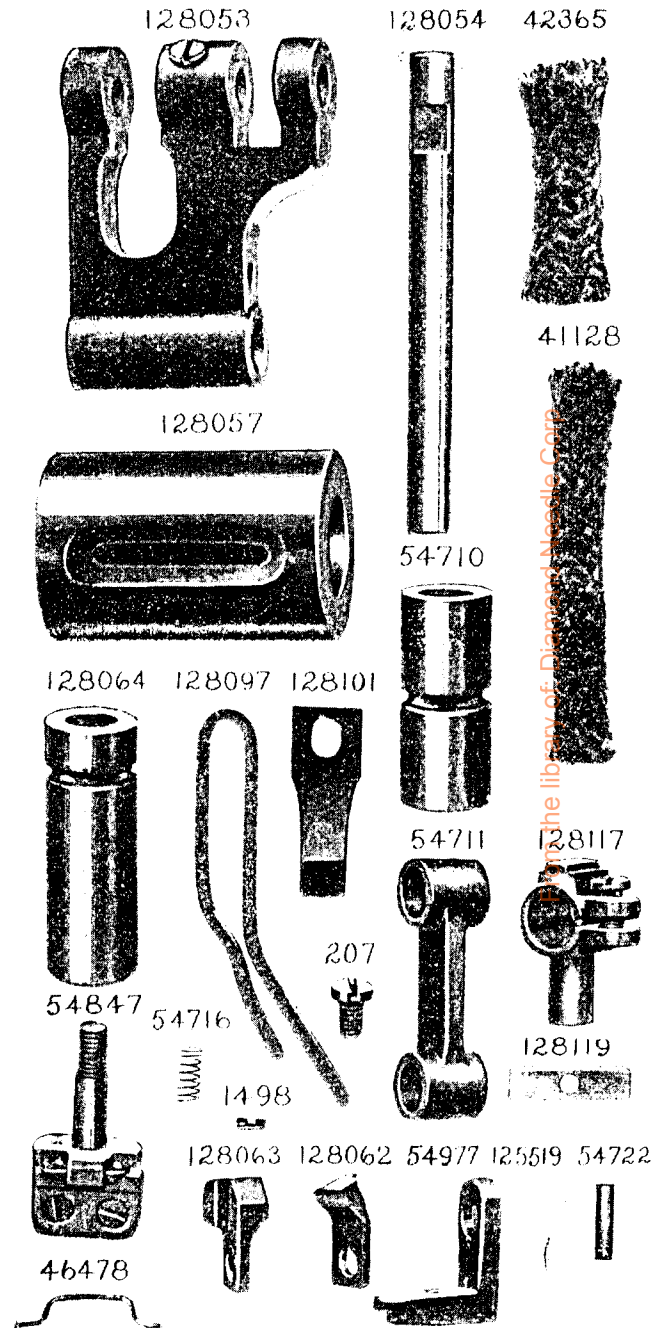


PLATE 9112—ONE-HALF SIZE

128043 128050 128056 54708 128071

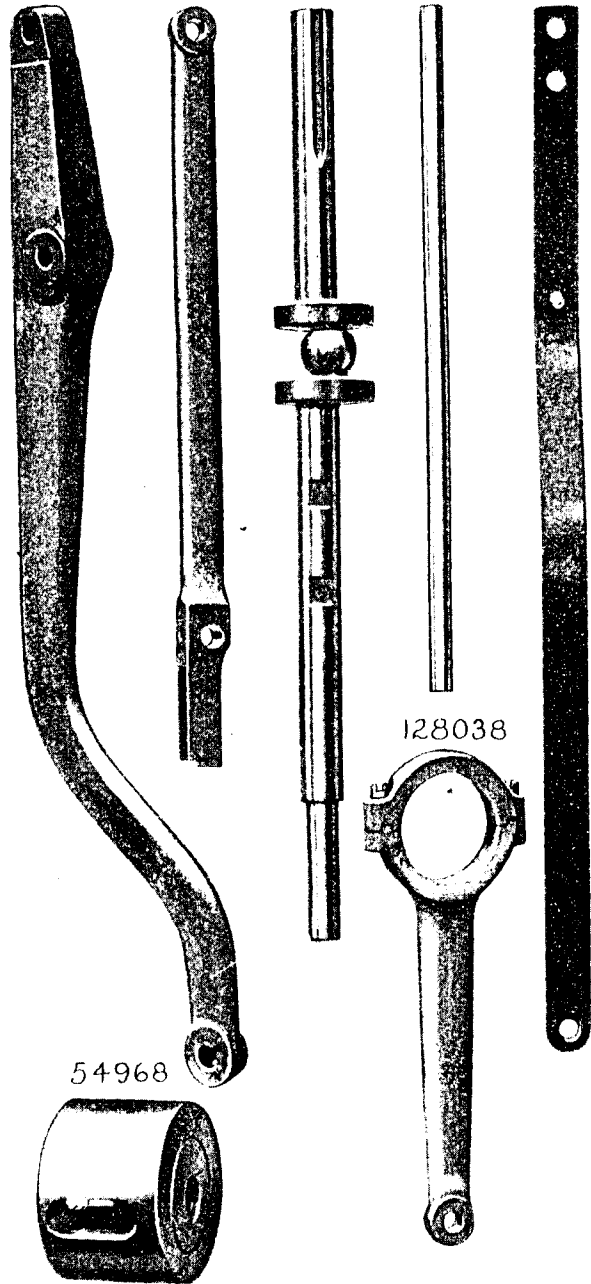


PLATE 9115—FULL SIZE

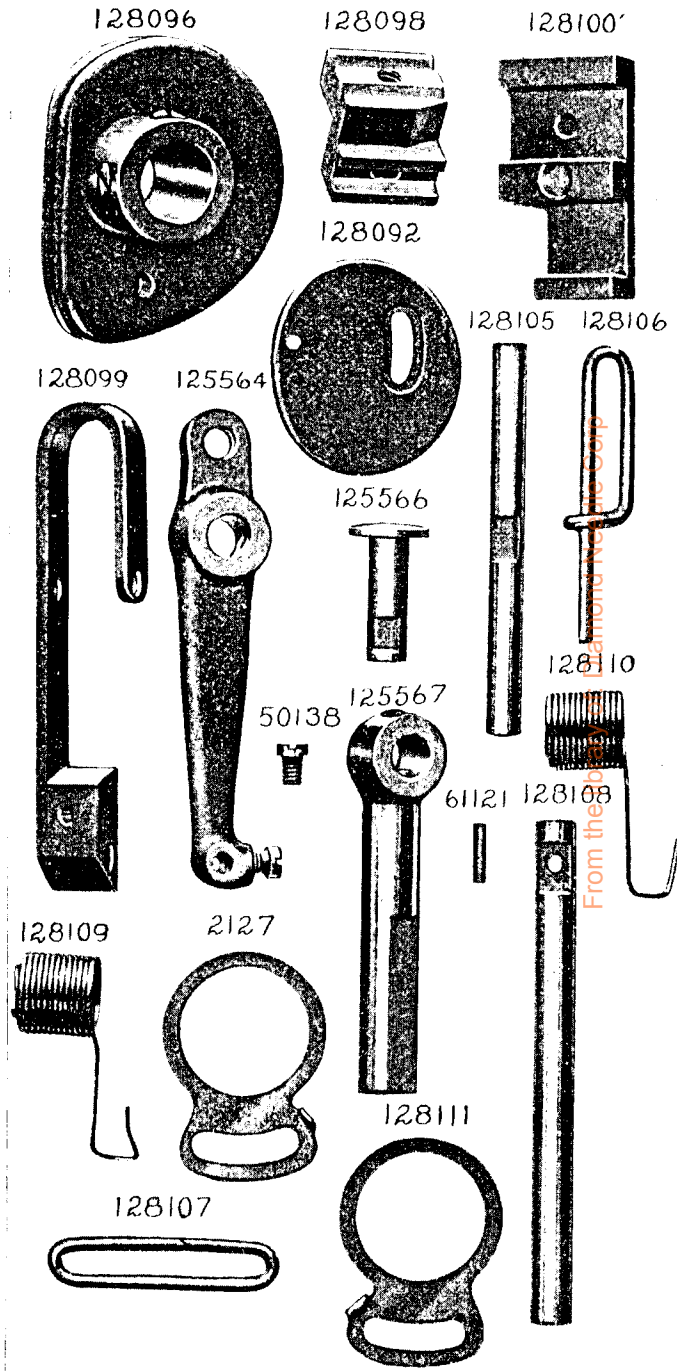


PLATE 9117—FULL SIZE

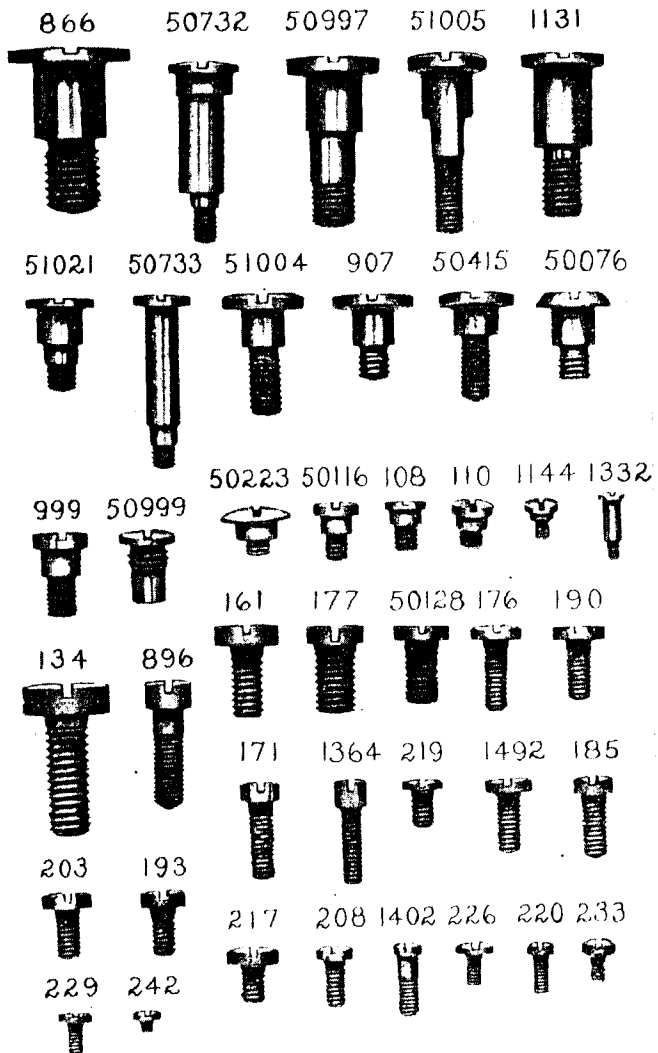
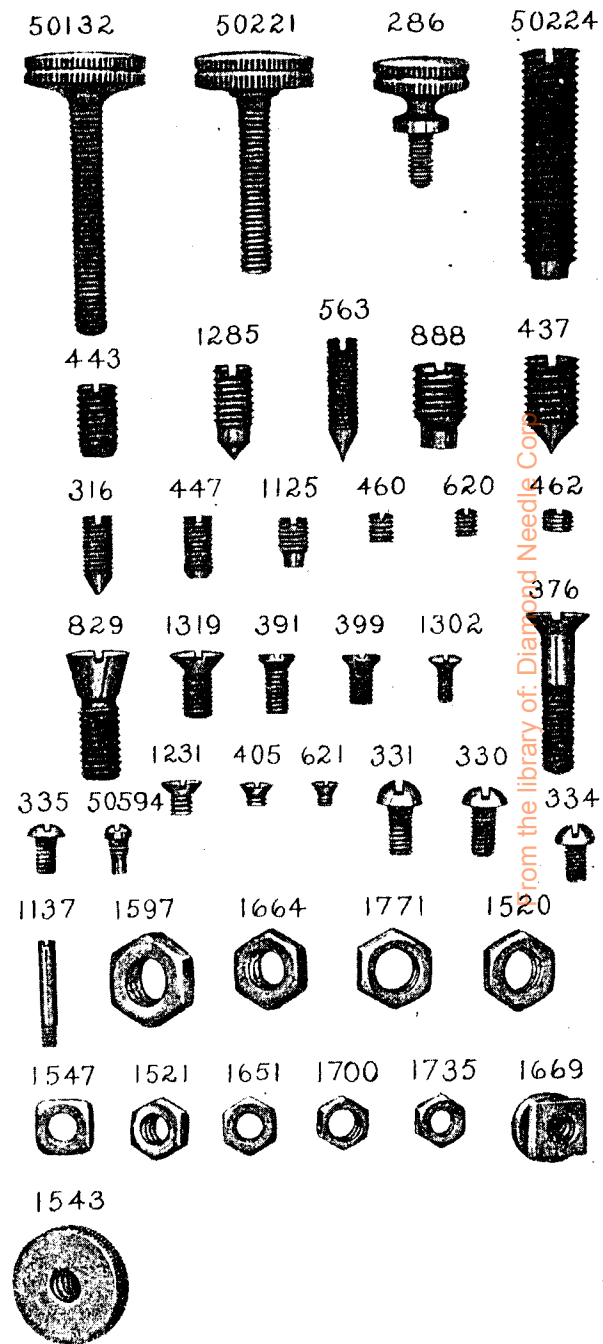


PLATE 9118—FULL SIZE



from the library of Diamond Needle Corp.

PLATE 9119—ONE-FOURTH SIZE

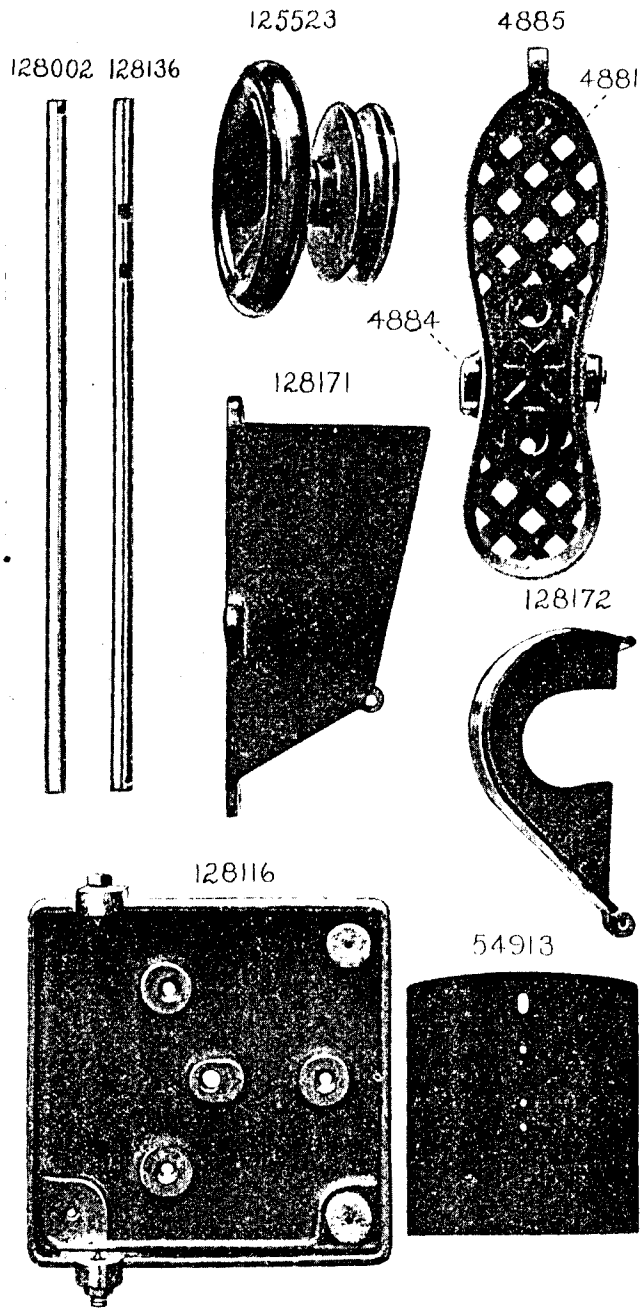


PLATE 9121—FULL SIZE

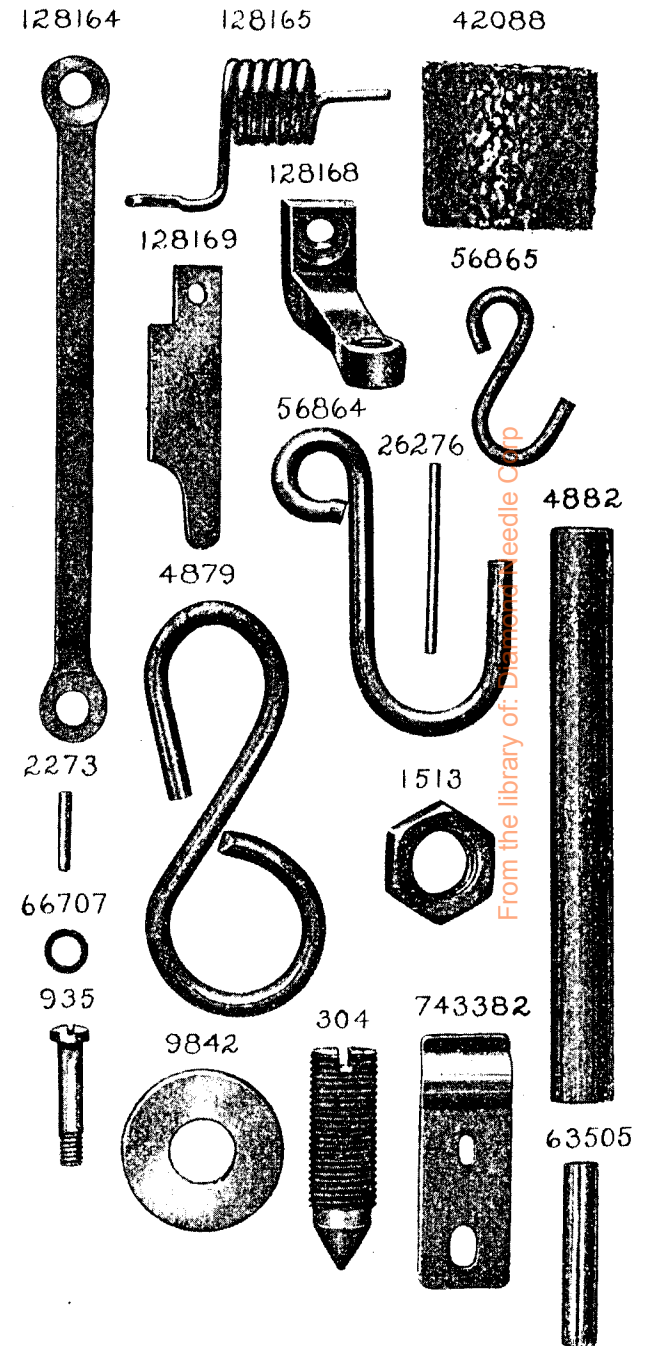
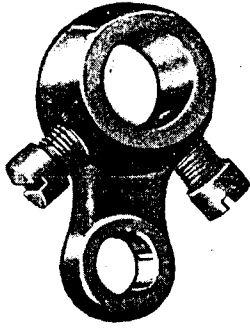
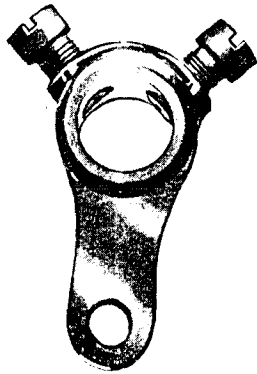


PLATE 9122--FULL SIZE

128262



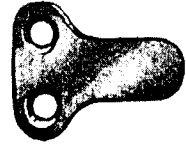
128006



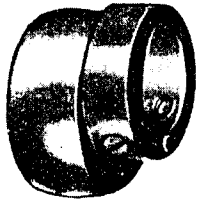
51043



128271



128203



128382



50084



67425



128199



1722



128200



1723



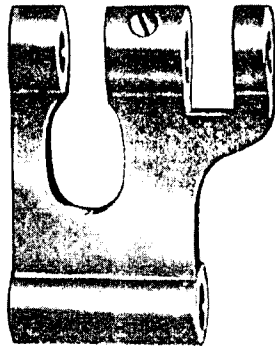
662



452



128053



445



664

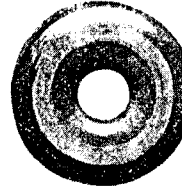


128390

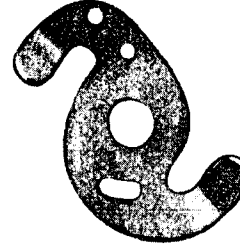


PLATE 9131--FULL SIZE

2102



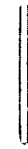
128221



59534



128225



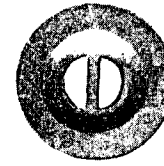
128081



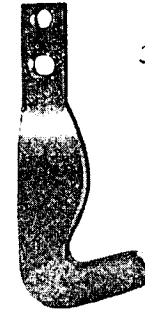
51034



32572



128222



59536



128078



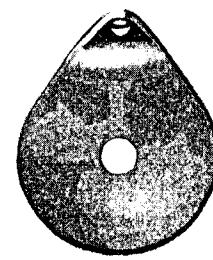
735



170



17547



337



63824



59537



128227



50326



59538



51570



128224



From the library of: Diamond Needle Corp

PLATE 9137—ONE-FOURTH SIZE

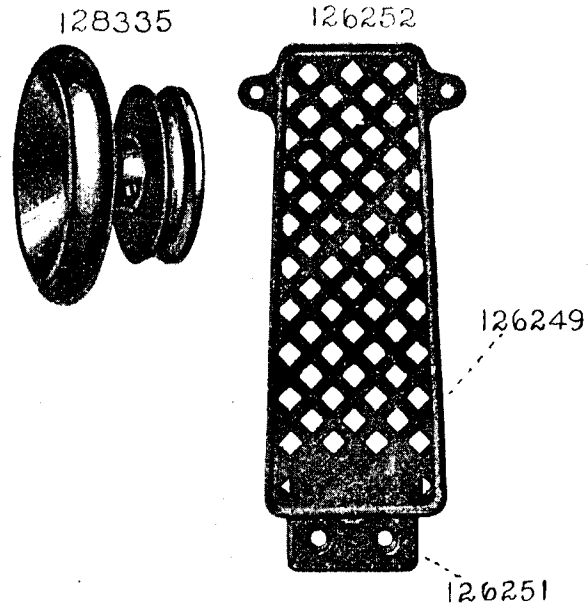
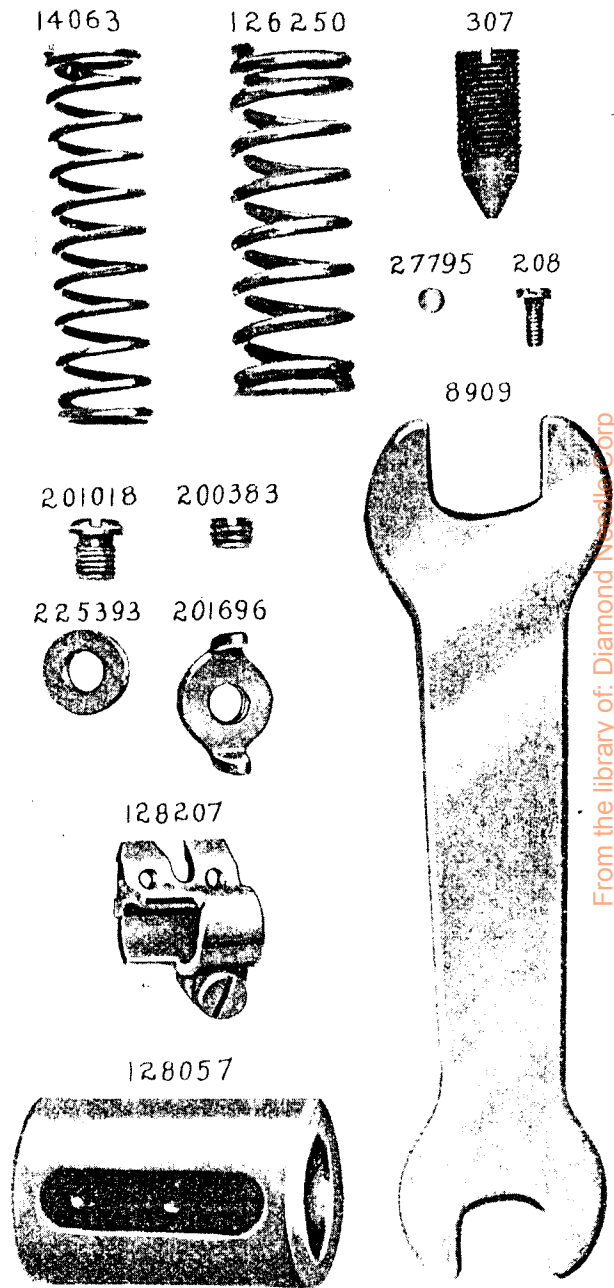


PLATE 9140—FULL SIZE



From the library of: Diamond Needle Corp

PLATE 9143—ONE-HALF SIZE

128336 128084 128050 128083 54879

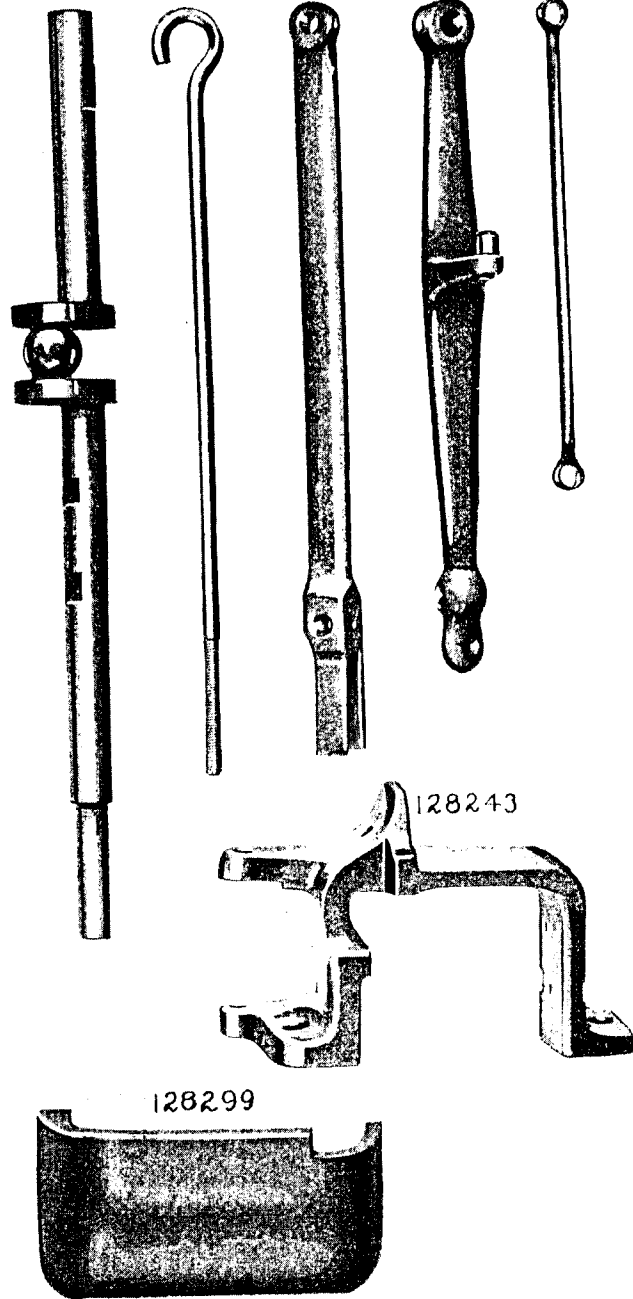
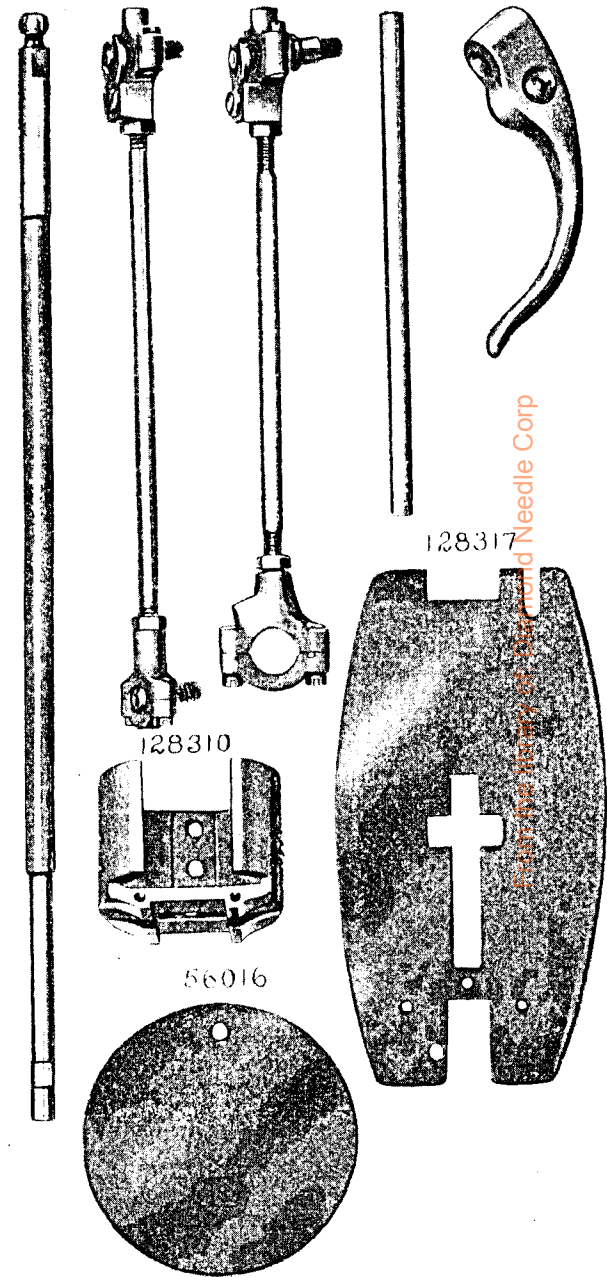


PLATE 9150—ONE-HALF SIZE

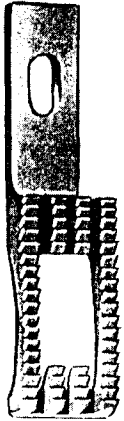
128014 128021 128264 128065 128047



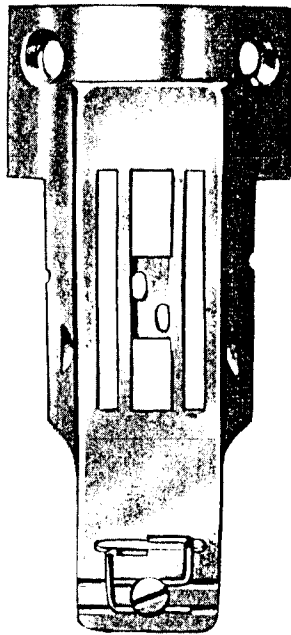
Illustrations by Henry S. Stevens and Needle Corp

PLATE 9700—FULL SIZE

128319



128326



128321



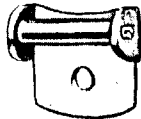
128327 128328



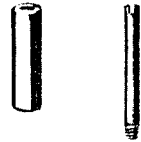
128313



128314



128315 811



224



128322



128316



PLATE 9701—FULL SIZE

55



50083



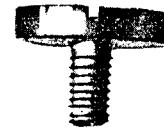
50135



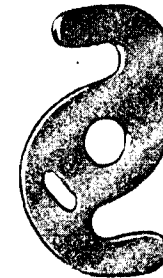
440



150



128076



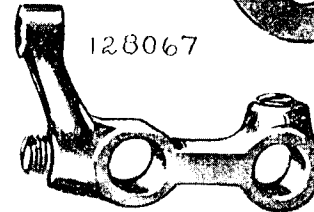
128120



453 50150



128067



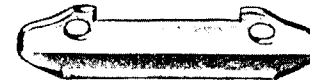
448 1477



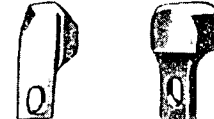
128080 51818



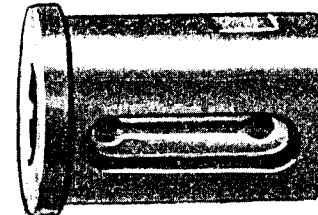
128312



128256 128257



128388



From the library of: Diamond Needle Corp